

PROFILINE

KLEEMANN SPARE PARTS

Germany



German quality repair and accessories parts

SUSPENSION



www.profiline.com

So erreichen Sie uns/ contact to us

Verkauf/ Sales

phone: +49 33056/ 2873 -10/ -11

telefax: +49 33056/ 2873-33

mail: sales@profiline.com

Gewährleistungen/ Warrenty

phone: +49 33056/ 2873 -11

telefax: +49 33056/ 2873-33

Buchhaltung/ Accounting

phone: +49 33056/ 2873 -38

telefax: +49 33056/ 2873-39

mail: accounting@profiline.com

Lager-Versand/ Storekeeper

phone: +49 33056/ 2873 -58/ -59

telefax: +49 33056/ 2873-44

Geschäftsleitung/ Management

phone: +49 33056/ 2873 -27/ -10

telefax: +49 33056/ 2873-21

mail: kleemann@profiline.com

Das PROFILINE-Team

Service steht für uns an erster Stelle.

Damit unsere Ersatzteile schnell bei Ihnen sind, achten wir auf eine hohe Verfügbarkeit und stehen Ihnen mit einem zuverlässigen Lieferservice zur Seite-weltweit.

Wir freuen uns auf eine erfolgreiche Zusammenarbeit mit Ihnen.

The PROFILINE-Team

Service is our number one priority.

So that our replacement parts are fast to you, we pay attention to high availability and are available world-wide with a reliable delivery service.

We look forward to a successful cooperation with you.

Dear customer,

thank you for your interest in our products.

This catalogue includes a well considered spare-part-assortment of high class articles.

Herewith you gain purchase-informations of PROFILINE Import-Export GmbH.

Dear customer,

PROFILINE brand spare parts are no original parts of any vehicle-maker.

PROFILINE is registered and trademarked.

Important Notes

All stated informations are based on available documentations.

Liabilities cannot be assumed for any errors or omissions.

All informations are subject to technical changes. Part numbers, descriptions or manufactures are for comparison purposes only. They are no indication of origin parts and should not be used to endconsumers. Any claims based on given catalogue-datas will not be admitted.

Reprints, reproductions also in extracts require written permission.

How do I become a PROFILINE customer ?

Just complete our FORM and return same to us.

If requested the FORM will be submitted.

Offers

We offer spare parts at best possible terms and at rock-bottom prices.

Therefore extra discounts or bonus agreements or other allowances cannot be granted additionally.

Deliveries

All prices to be understood EX WAREHOUSE Mühlenbeck.

If assistance is required we can deliver ordered spare parts at low transportation costs to you. Following alternatives can be offered:

National Parcel Service (48 hours service)

International Parcel Service (delivery-time dependent on the country)

National Overnight Service (delivery next working day at 9 AM, a respective locker-facility is required)

National Daytime Service (delivery next working day between 8.00 to 12.00 AM)

Ordinary national or international deliveries by truck, ship or aircraft

Service

Service for us ranks first.

For this reason we pay attention to a high availability rate of our spare part offer and assure our customers professional support.

Imprint

Profiline Import-Export GmbH, Buchhorster Str. 23, D-16567 Mühlenbeck, Germany

Tel: +49 33056 2873-10 / -11, FAX: +49 33056 2873-33 E-Mail: kleemann@profiline.com

Internet: www.profiline.info

Register of companies: Amtsgericht Neuruppin HRB9256NP

VAT-Reg. No: DE 173223636 / TAX-Number: 053/116/02359

Bank: Berliner Sparkasse BLZ: 10050000 Account No.: 630033099

BIC: BELADEBEXX

IBAN: DE 16 1005 0000 0630033099

manager: Andreas Kleemann

PL-number	pf./ applicable for	OE/ OEM-Ref.	Dimension	picture
015 144 000	Vorderachse/ front axle			
Stabilisator stabilizer	MB Bus O303-304-340	301 323 00 65	1000x880x510 D=50	

PL-number	pf./ applicable for	OE/ OEM-Ref.	Dimension	picture
015 101 016				
Lagerung Stabilisator bushing for stabilizer	015 144 000 (4x)	301 326 00 81	DA=82/ DI=50 H=80	







PL-number	pf./ applicable for	OE/ OEM-Ref.	Dimension	picture
015 144 001	Vorderachse/ front axle			
Stabilisator stabilizer	MB Bus O350-403-404	356 320 03 11	1112x1194x457 D=38 Auge/ Eye DI=20	







PL-number	pf./ applicable for	OE/ OEM-Ref.	Dimension	picture
015 101 012				
Lagerung Stabilisator bushing for stabilizer	015 144 001 (4x)	356 326 00 81	DA=64/ DI=36/ H=60	

PL-number	pf./ applicable for	OE/ OEM-Ref.	Dimension	picture
015 101 011				
Lagerung Stabilisator bushing for stabilizer	015 144 001 (2x)	356 323 00 81	DA=49/ DI=20 H=40	

PL-number	pf./ applicable for	OE/ OEM-Ref.	Dimension	picture
015 144 002	Vorderachse/ front axle			
Stabilisator stabilizer	MB Truck (BM371-698) MK/ NG/ SK/ Unimog	620 323 01 65 652 323 07 65	1160x371x36	

PL-number	pf./ applicable for	OE/ OEM-Ref.	Dimension	picture
015 101 017				
Lagerung Stabilisator bushing for stabilizer	015 144 002 (1x)	620 320 06 28	DA1=70 DA2=82/ ID=37 H=62	

PL-number	pf./ applicable for	OE/ OEM-Ref.	Dimension	picture
015 101 018				
Lagerung Stabilisator bushing for stabilizer	015 144 002 (x2)	387 323 02 85	DA=70/ DI=37 H=62	
PL-number	pf./ applicable for	OE/ OEM-Ref.	Dimension	picture
015 144 003	Hinterachse/ rear axle			
Stabilisator stabilizer	MAN Bus SR240-280	81.43715.0047	1060x1170x475 D=55	
PL-number	pf./ applicable for	OE/ OEM-Ref.	Dimension	picture
015 201 007				
Lagerung Stabilisator bushing for stabilizer	015 144 003 (4x)	81.43704.0045 81.43704.0028	DA=87/ DI=55 H=80	
PL-number	pf./ applicable for	OE/ OEM-Ref.	Dimension	picture
015 144 004	Hinterachse/ rear axle			
Stabilisator stabilizer	MAN Bus SR-SL-SÜ (Baujahr 72-94)	81.43715.0043	1210x545 D=55	
PL-number	pf./ applicable for	OE/ OEM-Ref.	Dimension	picture
015 201 007				
Lagerung Stabilisator bushing for stabilizer	015 144 004 (8x)	81.43704.0045 81.43704.0028	DA=87/ DI=55 H=80	
PL-number	pf./ applicable for	OE/ OEM-Ref.	Dimension	picture
015 144 005	Vorderachse/ front axle			
Stabilisator stabilizer	MAN Bus A03-13-33-52-53	81.43715.0091	1000x955x360 D=45 Auge DI=16	
PL-number	pf./ applicable for	OE/ OEM-Ref.	Dimension	picture
015 201 006				
Lagerung Stabilisator bushing for stabilizer	015 144 005 (4x)	81.43704.0057	DA=67/ DI=44 H=60	

PL-number	pf./ applicable for	OE/ OEM-Ref.	Dimension	picture
015 201 005				
Lagerung Stabilisator bushing for stabilizer	015 144 005 (2x)	81.96210.0469 81.43722.0038 81.96210.0450	DA=47/ DI=16 H=40	
015 144 006	Vorderachse/ front axle			
Stabilisator stabilizer	MAN Bus SÜ-ÜL-ND-RH-ND LionsStar-Coach-City-Regio Neoplan Jet-Sky-Star-City-Tour-Trendliner	81.43715.0100 81.43715.6064	1000x370x45 Auge DI=16	
015 201 006				
Lagerung Stabilisator bushing for stabilizer	015 144 006 (4x)	81.43704.0057	DA=67/ DI=44 H=60	
015 201 010				
Lagerung Stabilisator bushing for stabilizer	015 144 006 (2x)	81.43722.0059	DA=50/ DI=16 H=47	
015 144 007	Hinterachse/ rear axle			
Stabilisator stabilizer	Setra 200er Serie	179.23.11.112.01	1142x1100x497 D=42 Auge DI=27	
015 301 004				
Lagerung Stabilisator bushing for stabilizer	015 144 007 (4x)	179.23.11.180.01	DA=73/ DI=42 L=80	
015 144 008	Vorderachse/ front axle			
Stabilisator stabilizer	Setra S210-S215 Setra SG219UL-SG221UL	179.23.11.111.02	1060x1093x493 D=42 Auge DI=27	

PL-number	pf./ applicable for	OE/ OEM-Ref.	Dimension	picture
015 301 004				
Lagerung Stabilisator bushing for stabilizer	015 144 008 (4x)	179.23.11.180.01	DA=73/ DI=42 L=80	

PL-number	pf./ applicable for	OE/ OEM-Ref.	Dimension	picture
015 144 009	Vorderachse/ front axle			
Stabilisator stabilizer	Setra 216/ 228DT	139.23.11.112.04	1045x1220x488 D=45 Auge DI=27	







PL-number	pf./ applicable for	OE/ OEM-Ref.	Dimension	picture
015 301 000				
Lagerung Stabilisator bushing for stabilizer	015 144 009 (4x)	4.771.325.000 001 988 24 10 628 322 00 50	DA=77/ DI=45 H=70	

PL-number	pf./ applicable for	OE/ OEM-Ref.	Dimension	picture
015 144 010	Vorderachse/ front axle			
Stabilisator stabilizer	Daf Bova	1286905 1286906	915x810x440 D=40 Auge DI=47	

PL-number	pf./ applicable for	OE/ OEM-Ref.	Dimension	picture
015 144 011	Vorderachse/ front axle			
Stabilisator stabilizer	Neoplan Euroliner, Cityliner, Starliner, Spaceliner, Skyliner N1122/3 (mit Achse VN9)	1101 591 7 36.43715.0000 1022.002.230	1020x1010x367 D=45 Auge DI=27	

PL-number	pf./ applicable for	OE/ OEM-Ref.	Dimension	picture
015 401 001				
Lagerung Stabilisator bushing for stabilizer	015 144 011 (4x)	N1.01101-5364	DA=77/ DI=45 H=70	

PL-number	pf./ applicable for	OE/ OEM-Ref.	Dimension	picture
015 144 012	Vorderachse/ front axle			
Stabilisator stabilizer	MB Bus O500R/ O500RSR	634 323 01 65	1050x854x470 D=50	

PL-number	pf./ applicable for	OE/ OEM-Ref.	Dimension	picture
015 101 016				
Lagerung Stabilisator bushing for stabilizer	015 144 012 (4x)	301 326 00 81	DA=82/ DI=50 H=80	
PL-number	pf./ applicable for	OE/ OEM-Ref.	Dimension	picture
015 144 013	Vorderachse/ front axle			
Stabilisator stabilizer	Scania Bus	141015	1020x1205x417 D=45	
PL-number	pf./ applicable for	OE/ OEM-Ref.	Dimension	picture
015 144 014	Hinterachse/ rear axle			
Stabilisator stabilizer	MB Bus O500U-M-RSD HA	634 326 02 65	1115x980x400 D=45	
PL-number	pf./ applicable for	OE/ OEM-Ref.	Dimension	picture
015 101 016	Hinterachse/ rear axle			
Lagerung Stabilisator bushing for stabilizer	015 144 014 (4x)	301 326 00 81	DA=82/ DI=50 H=80	
PL-number	pf./ applicable for	OE/ OEM-Ref.	Dimension	picture
015 144 015	Hinterachse/ rear axle			
Stabilisator stabilizer	MB Truck Actros	942 320 19 11	1050x1034x710 D=77	
PL-number	pf./ applicable for	OE/ OEM-Ref.	Dimension	picture
015 101 019				
Lagerung Stabilisator bushing for stabilizer	015 144 015 (2x)	942 326 00 50	DA=88/ DI=20,5 H=130	
PL-number	pf./ applicable for	OE/ OEM-Ref.	Dimension	picture
015 101 032				
Lagerung Stabilisator bushing for stabilizer	015 144 015 (2x)	941 326 00 50	DA=109/ DI=81 H=67	

PL-number	pf./ applicable for	OE/ OEM-Ref.	Dimension	picture
015 144 016				
Stabilisator stabilizer	Daf Bus & Truck	1286905 Daf 1286906 Daf	915x810 D=40	

PL-number	pf./ applicable for	OE/ OEM-Ref.	Dimension	picture
015 144 017	Vorderachse/ front axle			
Stabilisator stabilizer	MB Bus Citaro/ Connecto VA	628 323 00 65	115x1079x410 D=45	

PL-number	pf./ applicable for	OE/ OEM-Ref.	Dimension	picture
015 301 000				
Lagerung Stabilisator bushing for stabilizer	015 144 017 (4x)	4.771.325.000 001 988 24 10 628 322 00 50	DA=77/ DI=45 H=70	

PL-number	pf./ applicable for	OE/ OEM-Ref.	Dimension	picture
015 144 018	Hinterachse/ rear axle			
Stabilisator stabilizer	MB Conecto O345 MB Citaro Euro 2-5 Setra 415-416NF	628 326 02 65	880x980x450 D=45	

PL-number	pf./ applicable for	OE/ OEM-Ref.	Dimension	picture
015 301 000				
Lagerung Stabilisator bushing for stabilizer	015 144 018 (4x)	4.771.325.000 001 988 24 10 628 322 00 50	DA=77/ DI=45 H=70	

PL-number	pf./ applicable for	OE/ OEM-Ref.	Dimension	picture
015 144 019	Vorderachse/ front axle			
Stabilisator stabilizer	Volvo Bus B12B/ B12M	21243901	870x1400x430 D=45	

PL-number	pf./ applicable for	OE/ OEM-Ref.	Dimension	picture
015 500 1014				
Lagerung Stabilisator bushing for stabilizer	015 144 019 (2x)	70301194	DA=80/ DI=42 H=75	

PL-number	pf./ applicable for	OE/ OEM-Ref.	Dimension	picture
015 144 021	Vorderachse/ front axle			
Stabilisator stabilizer	MAN Bus NL-NG-ND LionsCity/ LionsCity DD Neoplan N4516-4521-4522	81.43715.0117 81.43715.6077	1000x1090x420 D=48	

PL-number	pf./ applicable for	OE/ OEM-Ref.	Dimension	picture
015 201 009				
Lagerung Stabilisator bushing for stabilizer	015 144 021 (4x)	81.43704.0076	DA=69/ DI=50 H=60	

PL-number	pf./ applicable for	OE/ OEM-Ref.	Dimension	picture
015 144 022	Hinterachse/ rear axle			
Stabilisator stabilizer	Volvo Bus B12R	70321663		

PL-number	pf./ applicable for	OE/ OEM-Ref.	Dimension	picture
015 144 023	Vorderachse/ front axle			
Stabilisator stabilizer	Volvo Bus B7R	70321664		

PL-number	pf./ applicable for	OE/ OEM-Ref.	Dimension	picture
015 144 024	Hinterachse/ rear axle			
Stabilisator stabilizer	Volvo Bus B7L/ B10L to chassi number CH1677	3112398		

PL-number	pf./ applicable for	OE/ OEM-Ref.	Dimension	picture
015 144 025	Hinterachse/ rear axle 1+2			
Stabilisator stabilizer	Volvo Bus B10M/ B10B/ B12 (front axle) B9S/ B10BM/ B10M (axle Nr.3) B12M (axle Nr.3)	70321662		

PL-number	pf./ applicable for	OE/ OEM-Ref.	Dimension	picture
015 144 026	Hinterachse/ rear axle 1+2			
Stabilisator stabilizer	Volvo Bus B10B/ B10M/ B12 (rear axle) B10M (axle Nr.3)	70321659		

PL-number	pf./ applicable for	OE/ OEM-Ref.	Dimension	picture
015 144 029	Hinterachse/ rear axle			
Stabilisator stabilizer	MB Truck Axor	943 326 05 65	1030x300x50	

PL-number	pf./ applicable for	OE/ OEM-Ref.	Dimension	picture
015 144 031	Hinterachse/ rear axle			
Stabilisator stabilizer	Volvo Bus B10M/ B10R/ B12	70321660		

PL-number	pf./ applicable for	OE/ OEM-Ref.	Dimension	picture
015 144 032	Vorderachse/ front axle			
Stabilisator stabilizer	Volvo Bus B10M/ B12	70321661		

PL-number	pf./ applicable for	OE/ OEM-Ref.	Dimension	picture
015 300 100	Vorderachse/ front axle			
Stabilisator stabilizer	MB Bus Travego Setra TopClass 400	629 003 00 32 629 003 00 32 629 323 01 65 629 323 03 65 629 003 04 65 629 003 05 65	945x1125x477 D=45 Auge DI=27	







PL-number	pf./ applicable for	OE/ OEM-Ref.	Dimension	picture
015 301 000	Vorderachse/ front axle			
Lagerung Stabilisator bushing for stabilizer	015 300 100 (4x)	4.771.325.000 001 988 24 10 628 322 00 50	DA=77/ DI=45 H=70	

PL-number	pf./ applicable for	OE/ OEM-Ref.	Dimension	picture

PL-number	pf./ applicable for	OE/ OEM-Ref.	Dimension	picture

PL-number	pf./ applicable for	OE/ OEM-Ref.	Dimension	picture
015 101 000	Hinterachse/ rear axle			
Lagerung Stabilisator bushing for stabilizer	MB Bus Citaro	628 320 02 73		
015 101 001	Hinterachse/ rear axle			
Lagerung Stabilisator bushing for stabilizer	MB Truck Atego/ Vario	314 326 01 53	DA=30/ DI=12/ H=30	
015 101 002	Vorderachse/ front axle			
Lagerung Stabilisator bushing for stabilizer	MB Truck NG	360 323 00 85	DI=39/ DA=58/ H=37	
015 101 003	Hinterachse/ rear axle			
Lagerung Stabilisator bushing for stabilizer	MB Truck NG	383 326 01 81	DI=50/ DA=95/ H=101	
015 101 004	Hinterachse/ rear axle			
Lagerung Stabilisator bushing for stabilizer	MB Truck LK-LN2 MB Bus O402	309 326 02 81	DI=34/ DA=45/ L=86	
015 101 005	Vorderachse/ front axle			
Lagerung Stabilisator bushing for stabilizer	MB Truck LK-LN2/ T2L/ T2-LN1 MB Bus O402	309 320 00 73	DI=12/ DA=30/ H=30	
015 101 006	Vorderachse/ front axle			
Lagerung Stabilisator bushing for stabilizer	MB Truck Actros	000 323 28 85 000 323 24 44	DA=40/ DI=20/ H=40	
015 101 007	Hinterachse/ rear axle			
Lagerung Stabilisator bushing for stabilizer	MB Truck T1	601 326 04 82	DI=24/ DA=35/ H=39	

PL-number	pf./ applicable for	OE/ OEM-Ref.	Dimension	picture
015 101 008	Hinterachse/ rear axle			
Lagerung Stabilisator bushing for stabilizer	MB Truck LK-LN2	608 333 00 14	DI=24/ DA=36/ L=42	
015 101 009	Hinterachse/ rear axle			
Lagerung Stabilisator bushing for stabilizer	MB Truck LK-LN2	673 326 05 81	DI=36/ DA=58/ L=62	
015 101 009				
Lagerung Stabilisator bushing for stabilizer	MB Truck T2/L	309 323 03 85	DI=30/ DA=48/ L=50	
015 101 011	Vorderachse/ front axle			
Lagerung Stabilisator bushing for stabilizer	MB Bus O350/ O404	356 323 00 81	DA=49/ DI=20/ H=40	
015 101 012	Vorderachse/ front axle			
Lagerung Stabilisator bushing for stabilizer	MB Bus O350/ O404	356 326 00 81	DA=64/ DI=36/ H=60	
015 101 013	Hinterachse/ rear axle			
Lagerung Stabilisator bushing for stabilizer	MB Bus O350/ O404	396 326 00 81	AD=69/ L=130	
015 101 014	Vorderachse/ front axle			
Lagerung Stabilisator bushing for stabilizer	MB Truck Actros	000 323 79 85 000 323 74 85 000 323 75 85	DA=70/ DI=40/ H=46	
015 101 015	Vorder-Hinterachse/ front and rear			
Lagerung Stabilisator bushing for stabilizer	MB Sprinter (BM901-902-903-904-906) MB T1/ T2-LN1 VW LT/ Crafter	601 321 03 50	DA=26/ DI=12/ H=26	

PL-number	pf./ applicable for	OE/ OEM-Ref.	Dimension	picture
015 101 016	Vorderachse/ front axle			
Lagerung Stabilisator bushing for stabilizer	MB Bus O303-304 -340-500	301 326 00 81	DA=82/ DI=50/ H=80	
015 101 017	Vorderachse/ front axle			
Lagerung Stabilisator bushing for stabilizer	MB Truck NG/ SK/ Unimog (BM371-698)	620 320 06 28	DA1=70/ DA2=82 ID=37/ H=62	
015 101 018	Vorderachse/ front axle			
Lagerung Stabilisator bushing for stabilizer	MB Truck NG/ SK/ Unimog (BM371-698)	387 323 02 85	DA=70/ DI=37/ H=62	
015 101 019				
Lagerung Stabilisator bushing for stabilizer	MB Truck Actros MP1/ MP2 Atego1+2/ Axor1+2	942 326 00 50	DA=88/ DI=20,5 H=130	
015 101 020	Hinterachse/ rear axle			
Lagerung Stabilisator bushing for stabilizer	MB Sprinter (BM904-906) VW LT/ Crafter	904 326 08 81	DI=27	
015 101 021	Hinterachse/ rear axle			
Lagerung Stabilisator bushing for stabilizer	MB Sprinter (BM904-906) VW Crafter	904 326 09 81	DI=30	
015 101 022	Hinterachse/ rear axle			
Lagerung Stabilisator bushing for stabilizer	MB Sprinter (BM 904)	904 326 10 81	DI=33	
015 101 023	Hinterachse/ rear axle			
Lagerung Stabilisator bushing for stabilizer	MB Sprinter	667 320 00 73	DA=32/ DI=12/ H=36	

PL-number	pf./ applicable for	OE/ OEM-Ref.	Dimension	picture
015 101 024	Vorderachse/ front axle			
Lagerung Stabilisator bushing for stabilizer	MB Truck Atego1/ Vario/ LK-LN2	318 320 00 73	DA=40/ DI=17/ H=34	
015 101 025	Vorderachse/ front axle			
Lagerung Stabilisator bushing for stabilizer	MB Sprinter 416CDI	904 323 00 85	DI=25	
015 101 026	Vorderachse/ front axle			
Lagerung Stabilisator bushing for stabilizer	MB Sprinter 416CDI	901 323 02 85	DA=26/ DI=13/ H=24	
015 101 027	Hinterachse/ rear axle			
Lagerung Stabilisator bushing for stabilizer	MB Sprinter 518CDI	906 326 04 81	DI=33	
015 101 028	Vorderachse/ front axle			
Lagerung Stabilisator bushing for stabilizer	MB Sprinter 518CDI	906 323 16 85	DI=23	
015 101 029	Hinterachse/ rear axle			
Lagerung Stabilisator bushing for stabilizer	MB Truck SK/ NK	655 326 05 81	DA=89/ DI=64/ H=74	
015 101 030	Vorderachse/ front axle			
Lagerung Stabilisator bushing for stabilizer	MB Truck MK/ SK/ Actros/ Atego	000 326 24 81	DA=50/ DI=40/ H=55	
015 101 031	Hinterachse/ rear axle			
Lagerung Stabilisator bushing for stabilizer	MB Truck Vario	670 326 02 81	DI=50	

PL-number	pf./ applicable for	OE/ OEM-Ref.	Dimension	picture
015 101 032	Vorderachse/ front axle			
Lagerung Stabilisator bushing for stabilizer	MB Truck Actros MP1-2 MB Truck Atego1+2/ Axor1+2	941 326 00 50	DA=109/ DI=81 H=67	
015 101 033	Vorderachse/ front axle			
Lagerung Stabilisator bushing for stabilizer	MB Truck Actros/ Atego	000 326 26 81 000 326 30 81 000 326 32 81	DA=74/ DI=47/ H=57	
015 101 033	Vorderachse/ front axle			
Lagerung Stabilisator bushing for stabilizer	MB Truck Vario	667 323 06 85	D=36/ L=37	
015 101 037	Vorderachse/ front axle			
Lagerung Stabilisator bushing for stabilizer	MB Truck Actros MP1-2/ Atego1 MB Truck Axor1/ Econic1	941 323 01 50	DI=70/ DA=99/ H=65	
015 101 038	Vorderachse/ front axle			
Lagerung Stabilisator bushing for stabilizer	MB Truck Actros MP1-2-3 MB Atego1/ Axor2	000 323 71 85 000 323 62 85	DI=28/ DA=52 B=38/ H=55	
015 101 039	Hinterachse/ rear axle			
Lagerung Stabilisator bushing for stabilizer	MB Truck Actros MP1-2-3 MB Atego1/ Axor1+2 MB Truck Econic1/ Zetros	000 323 81 85	DI=40/ DA=80/ H=57	
015 201 005	Vorderachse/ front axle			
Lagerung Stabilisator bushing for stabilizer	MAN Bus ÜL/ LionsCoach-City-Classic MAN Truck F90/ F-M-L2000 MAN Truck TGA-TGM-TGS-TGL-TGX Neoplan N4516-4521-4522	81.96210.0469 81.43722.0038 81.96210.0450	DA=47/ DI=16/ H=40	
015 201 006	Vorderachse/ front axle			
Lagerung Stabilisator bushing for stabilizer	MAN Bus LionsCoach-City-Star-Classic MAN Truck F90	81.43704.0057	DA=67/ DI=44/ H=60	

PL-number	pf./ applicable for	OE/ OEM-Ref.	Dimension	picture
015 201 007	Hinterachse/ rear axle			
Lagerung Stabilisator bushing for stabilizer	MAN Bus SL200	81.43704.0045 81.43704.0028	DA=87/ DI=55/ H=80	
015 201 009	Vorderachse/ front axle			
Lagerung Stabilisator bushing for stabilizer	MAN Bus NL-NG-ND/ LionsCity Neoplan N4516-4521-4522	81.43704.0076	DA=69/ DI=50/ H=60	
015 201 010	Vorderachse/ front axle			
Lagerung Stabilisator bushing for stabilizer	MAN Bus ÜL-NL-NM-ND LionsCity-Star-Classic-Regio-Coach MAN Truck TGA-TGL-TGM-TGS-TGX Neoplan N4516-20-21-22/ Skyliner Neoplan Starliner/ N1216-17-18 Neoplan N2216/ N3516	81.43722.0059	DA=50/ DI=16/ H=47	
015 201 012	Vorderachse/ front axle			
Lagerung Stabilisator bushing for stabilizer	MAN Truck G90-M90/ L2000/ M2000	81.43704.0029	DA=70/ DI=45/ H=90	
015 201 013	Vorderachse/ front axle			
Lagerung Stabilisator bushing for stabilizer	MAN Truck G90	81.96210.0278	DI=27/ DA=44/ H50	
015 201 013.1	Vorderachse/ front axle			
Lagerung Stabilisator bushing for stabilizer	MAN Truck G90	81.96210.0294	DI=12/ DA=34/ H=32	
015 201 014	Vorderachse/ front axle			
Lagerung Stabilisator bushing for stabilizer	MAN Bus EL-NG-EL-ÜL-SL-SG-SÜ MAN Bus LionsClassic	81.96210.0278	DA=64/ DI=24/ H=44	
015 201 016	Hinterachse/ rear axle			
Lagerung Stabilisator bushing for stabilizer	MAN Truck TGA-TGM-TGS-TGX	81.43722.0068 81.43722.0069 81.43722.0080	DA=85/ DI=50/ H=70	

PL-number	pf./ applicable for	OE/ OEM-Ref.	Dimension	picture
015 201 018	Vorderachse/ front axle			
Lagerung Stabilisator bushing for stabilizer	MAN Bus ÜL-NL-NM-ND LionsCity-Star-Classic-Regio-Coach MAN Truck TGA-TGL-TGM-TGS-TGX Neoplan N4516-20-21-22/ Skyliner Neoplan Starliner/ N1216-17-18 Neoplan N2216/ N3516	81.43704.0078	DA=75/ DI=45/ H=50	
015 201 019	Hinterachse/ rear axle			
Lagerung Stabilisator bushing for stabilizer	MAN Truck TGA-TGM-TGS-TGX	81.43722.0083	DA=88/ DI=60/ H=60	
015 201 020	Vorderachse/ front axle			
Lagerung Stabilisator bushing for stabilizer	MAN Truck E2000-F2000-M2000/ CLA	81.43704.0074	DA=64/ DI=44/ H=65	
015 201 021	Hinterachse/ rear axle			
Lagerung Stabilisator bushing for stabilizer	MAN Truck F90	81.43704.0060	DA=78/ DI=54/ H=60	
015 201 022	Hinterachse/ rear axle			
Lagerung Stabilisator bushing for stabilizer	MAN Truck TGA-TGS-TGX	81.43704.0061	DA=78/ DI=60/ H=60	
015 201 023	Vorderachse/ front axle			
Lagerung Stabilisator bushing for stabilizer	MAN Truck L2000/ M2000	81.43722.0052	DA=55/ DI=34/ H=60	
015 201 024	Vorderachse/ front axle			
Lagerung Stabilisator bushing for stabilizer	MAN Truck	81.43704.0044 81.43722.0061	DA=82/ DI=55/ H=80	
015 201 025	Vorder-Hinterachse/ front and rear			
Lagerung Stabilisator bushing for stabilizer	MAN Truck L2000/ M2000	81.43722.0053	DA=56/ DI=39/ H=60	

PL-number	pf./ applicable for	OE/ OEM-Ref.	Dimension	picture
015 201 026	Hinterachse/ rear axle			
Lagerung Stabilisator bushing for stabilizer	MAN Bus A62 MAN Truck F90	81.43271.0080	DA=65/ DI=15	
015 201 027	Hinterachse/ rear axle			
Lagerung Stabilisator bushing for stabilizer	MAN Truck F90 Man Truck M2000-F2000-M2000 MAN Truck TGA-TGM-TGS-TGX	81.43722.0040 81.43722.0042	DA=84/ DI=56/ H=70	
015 201 028	Hinterachse/ rear axle			
Lagerung Stabilisator bushing for stabilizer	MAN Truck F90 Man Truck M2000-F2000-M2000 MAN Truck TGA-TGM-TGS-TGX	81.43722.0046 81.43722.0081 81.43722.0063	DA=68/ DI=22/ H=62	
015 201 030	Hinterachse/ rear axle			
Lagerung Stabilisator bushing for stabilizer	MAN Truck	81.43271.0011 81.43271.0021 81.43271.0022	DA=55/ DI=18/ H=55	
015 201 031	Vorderachse/ front axle			
Lagerung Stabilisator bushing for stabilizer	MAN Bus LionsCity/ NL/ NG/ ND MAN Truck TGA-TGL-TGS-TGM Neoplan Centroliner N4516-4520	81.43704.0077	DA=75/ DI=50/ H=51	
015 201 032	Vorderachse/ front axle			
Lagerung Stabilisator bushing for stabilizer	MAN Truck TGA-TGS-TGX	81.96210.0630	DI=18/ DA=42/ L=47	
015 301 000	Vorderachse/ front axle			
Lagerung Stabilisator bushing for stabilizer	MB Bus O404 (Hinterachse) O580 Travego (VA+HA) Citaro BM628-629 (Vorderachse) Setra 300er Serie alle (VA+HA) Setra 400er Serie HD-HDH (VA+HA)	4.771.325.000 001 988 24 10 628 322 00 50	DI=45/ DA=77/ H=70	
015 301 004	Vorderachse/ front axle			
Lagerung Stabilisator bushing for stabilizer	Setra Serie/ mod.200-300	179.23.11.180.01	DI=42/ DA=73/ L=80	

PL-number	pf./ applicable for	OE/ OEM-Ref.	Dimension	picture
015 500 1001	Hinterachse/ rear axle			
Lagerung Stabilisator bushing for stabilizer	Volvo Bus B10B/ B12 Volvo Truck F10-12-16/ FH12-16 Volvo Truck FL7-10-12/ FM7-9-10-12	1134955	DI=28/ DA=57/ H=64	
015 500 1003	Vorder-Hinterachse/ front and rear			
Lagerung Stabilisator bushing for stabilizer	Volvo Truck F10 Daf Truck 65-75-85-95/ 95XF/ XF95 Daf Truck CF75-85/ F2800-3600	308852 119140	DI=25/ DA=37/ H=26	
015 500 1004	Vorderachse/ front axle			
Lagerung Stabilisator bushing for stabilizer	Volvo Bus B7/ B7R/ B58 Volvo Truck F10-12	0363864	DI=45/ DA=71/ H=106	
015 500 1005	Vorder-Hinterachse/ front and rear			
Lagerung Stabilisator bushing for stabilizer	Volvo Bus B10M/ B12 Volvo Truck F10-12-16/ FH12-16 Volvo Truck FM10-12	1605047-8	DI=60/ DA=90/ H=73	
015 500 1006	Hinterachse/ rear axle			
Lagerung Stabilisator bushing for stabilizer	Volvo Truck F10-12-16 Volvo Truck FL6-7-10-12 Volvo Truck FH12-16	1607561-7	DI=62/ DA=74/ H=96	
015 500 1007	Vorder-Hinterachse/ front and rear			
Lagerung Stabilisator bushing for stabilizer	Volvo Truck F10-12	1573032-8	DI=50/ DA=71/ H=105	
015 500 1009	Vorderachse/ front axle			
Lagerung Stabilisator bushing for stabilizer	Volvo Truck FL7-10-12/ F10-12-16	1606437	DI=57/ DA=70/ L=91	
015 500 1010	Hinter-Nachlaufachse/ axle Nr.2 and 3			
Lagerung Stabilisator bushing for stabilizer	Volvo Truck FM9-12/ FH12-16/ FL6	1079225	DI=59/ DA=108/ H=78	

PL-number	pf./ applicable for	OE/ OEM-Ref.	Dimension	picture
015 500 1011	Vorder-Hinterachse/ front and rear			
Lagerung Stabilisator bushing for stabilizer	Volvo Bus B7R/ B7F/ B9S/ B10M Volvo Bus B10B/ B12B/ B12M/ B58 Volvo Truck FL6	9959304	DI=50/ DA=78-91 H=95	

PL-number	pf./ applicable for	OE/ OEM-Ref.	Dimension	picture
015 500 1013				
Lagerung Stabilisator bushing for stabilizer	Volvo Truck FH12-16/ FM7-9	9516524	DA=80/ DI=53/ H=75	

PL-number	pf./ applicable for	OE/ OEM-Ref.	Dimension	picture
015 500 1014				
Lagerung Stabilisator bushing for stabilizer	Volvo Bus B6/ B7F/ B7L/ B7L-DD/ B7R Volvo Bus B9R/ B10B/ B10M/ B11R Volvo Bus B12M/ B12B/ B13R	70301194	DA=80/ DI=42/ H=75	

PL-number	pf./ applicable for	OE/ OEM-Ref.	Dimension	picture
015 500 1015				
Lagerung Stabilisator bushing for stabilizer	Volvo Truck FH12-16/ FM7-9	1620750	DA=65,5/ DI=34/ H=64	

PL-number	pf./ applicable for	OE/ OEM-Ref.	Dimension	picture
015 500 1016				
Lagerung Stabilisator bushing for stabilizer	Volvo Bus B9R Volvo Truck FM9.12/ FH12/ FL6	3173991	DI=48/ DA=76/ H=70	

PL-number	pf./ applicable for	OE/ OEM-Ref.	Dimension	picture
015 500 1017				
Lagerung Stabilisator bushing for stabilizer	Volvo Truck FL6-608-615-616-619/ FS7	6799680	DI=70/ DA1=90 DA2=114	

PL-number	pf./ applicable for	OE/ OEM-Ref.	Dimension	picture
015 501 1006				
Lagerung Stabilisator bushing for stabilizer	Iveco EuroCargo (Vorderachse)	08127910	DI=35/ L=55 B1=59/ B2=60	

PL-number	pf./ applicable for	OE/ OEM-Ref.	Dimension	picture
015 501 1007				
Lagerung Stabilisator bushing for stabilizer	Iveco EuroCargo (Hinterrachse)	08127383	DA=66/ DI=40/ H=62	

PL-number	pf./ applicable for	OE/ OEM-Ref.	Dimension	picture
015 501 1008				
Lagerung Stabilisator bushing for stabilizer	Iveco EuroCargo (Hinterrachse)	8125492	DA=66/ DI=34/ H=62	
015 501 1011				
Lagerung Stabilisator bushing for stabilizer	Iveco C505 Irisbus Daily HA oben/ rear axle top	93801623	DI=24/ DA=32 L=40/ B=39	
015 501 1012				
Lagerung Stabilisator bushing for stabilizer	Iveco C505 Irisbus Daily HA rechts sowie links rear axle left and right	93801557	DI=56/ DA=60/ B=90	
015 502 1001				
Lagerung Stabilisator bushing for stabilizer	Renault Truck Magnum/ Kerax Magnum E-Tech/ Midlum/ Premium	5010239670	DA=70-60,5/ DI=42 H=62-21	
015 502 1002				
Lagerung Stabilisator bushing for stabilizer	Renault Truck Magnum/ Midlum MagnumE-Tech/ Premium	5010383545	DA=55/ DI=20/ H=41	
015 502 1003				
Lagerung Stabilisator bushing for stabilizer	Renault Truck Serie TR/ GR/ GRH/ R	0000716243	DA=63/ DI=38/ H=70	
015 502 1004				
Lagerung Stabilisator bushing for stabilizer	Renault Truck C/ G/ TR/ FT/ R/ Kerax Magnum/ Manager/ Maxter/ Midliner	0000714088	DA=49/ DI=25/ H=49	
015 502 1005				
Lagerung Stabilisator bushing for stabilizer	Renault Truck C/ G/ R Kerax Manager/ Maxter/ Midliner	5010557315	DA=67/ DI=39 H=62-73	

PL-number	pf./ applicable for	OE/ OEM-Ref.	Dimension	picture
015 502 1006				
Lagerung Stabilisator bushing for stabilizer	Renault Truck Mascott VA/ front axle	5010630049	DI=49/ DA=64/ B=59	

PL-number	pf./ applicable for	OE/ OEM-Ref.	Dimension	picture
015 502 1007				
Lagerung Stabilisator bushing for stabilizer	Renault Truck Serie C-G-R/ Kerax Manager/ Maxter/ Midliner/ Midlum	5000464786	DI=49/ DA=64/ B=59	

PL-number	pf./ applicable for	OE/ OEM-Ref.	Dimension	picture
015 502 1008				
Lagerung Stabilisator bushing for stabilizer	Renault Truck Serie C/ Kerax Maxter/ Midlum	5010130023	DI=34/ DA=67/ L=60	

PL-number	pf./ applicable for	OE/ OEM-Ref.	Dimension	picture

PL-number	pf./ applicable for	OE/ OEM-Ref.	Dimension	picture

PL-number	pf./ applicable for	OE/ OEM-Ref.	Dimension	picture

PL-number	pf./ applicable for	OE/ OEM-Ref.	Dimension	picture

PL-number	pf./ applicable for	OE/ OEM-Ref.	Dimension	picture

PL-number	pf./ applicable for	OE-Ref.	Dimension	picture
015 100 003				
Koppelstange steering rod	MB Citaro VA links	628 320 00 89 628 320 10 89	L=260 Konus=26 M20x1,5	

PL-number	pf./ applicable for	OE-Ref.	Dimension	picture
015 100 004				
Koppelstange steering rod	MB Citaro VA rechts	628 320 02 89 628 320 11 89	L=260 Konus=26 M20x1,5	

PL-number	pf./ applicable for	OE-Ref.	Dimension	picture
015 100 005				
Koppelstange steering rod	MB Bus O345 HA links MB Citaro HA Links S315NF Euro3 HA LI Neoplan	628 320 01 89 628 320 12 89 1105 821 2	L=260 Konus=26 M20x1,5	

PL-number	pf./ applicable for	OE-Ref.	Dimension	picture
015 100 006				
Koppelstange steering rod	MB Bus O345 HA rechts MB Citaro HA rechts S315NF Euro3 HA RE Neoplan	628 320 03 89 628 320 13 89 1105 821 5	L=260 Konus=26 M20x1,5	

PL-number	pf./ applicable for	OE-Ref.	Dimension	picture
015 100 007				
Koppelstange steering rod	MB Citaro Low Entry VA links/ left	628 320 08 89	L=270 Konus=26 Bohrung=18,2	

PL-number	pf./ applicable for	OE-Ref.	Dimension	picture
015 100 008				
Koppelstange steering rod	MB Citaro Low Entry VA rechts/ right	628 320 09 89	L=270 Konus=26 Bohrung=18,2	

PL-number	pf./ applicable for	OE-Ref.	Dimension	picture
015 100 009				
Koppelstange steering rod	MB Bus O500	634 323 03 16 634 323 05 16	L=375 Konus=26	

PL-number	pf./ applicable for	OE-Ref.	Dimension	picture
015 100 009				
Koppelstange steering rod	MB Bus O500	634 323 02 16 634 323 04 16	L=375 Konus=26	

PL-number	pf./ applicable for	OE-Ref.	Dimension	picture
015 200 001				
Koppelstange steering rod	MAN Truck TGL	85.43718.6014 85.43718.6008	L=345 DI=16 B=36	

PL-number	pf./ applicable for	OE-Ref.	Dimension	picture
015 200 002				
Koppelstange steering rod	MAN Truck TGL	85.43718.6015 85.43718.6007	L=345 DI=16 B=36	

PL-number	pf./ applicable for	OE-Ref.	Dimension	picture
015 300 000				
Koppelstange steering rod	Setra Bus 200er Serie VA	139.23.39.140.02 139.23.11.170.01	260x130	

PL-number	pf./ applicable for	OE-Ref.	Dimension	picture
015 300 000.1				
Koppelstange steering rod	Setra Bus 200er Serie HA	315.23.31.110.02	230x130	

PL-number	pf./ applicable for	OE-Ref.	Dimension	picture
015 300 001				
Koppelstange steering rod	Setra Bus 300er Serie VA	179-23.11.180.02	266x130	

PL-number	pf./ applicable for	OE-Ref.	Dimension	picture
015 300 002				
Koppelstange steering rod	Setra Bus 300er-400er Serie VA links	000 320 02 32 000 320 08 32 8.226.369.000	L=148	

PL-number	pf./ applicable for	OE-Ref.	Dimension	picture
015 300 003				
Koppelstange steering rod	Setra/ Evobus S228DT-328DT-431DT rechts/ right	VA 8.226.250.000	L=148 Konus=30 D=31	

PL-number	pf./ applicable for	OE-Ref.	Dimension	picture
015 300 004				
Koppelstange steering rod	Setra/ Evobus S228DT-328DT-431DT links/ left	VA 8.226.249.000	L=148 Konus=30 D=31	

PL-number	pf./ applicable for	OE-Ref.	Dimension	picture
015 300 006				
Koppelstange steering rod	Setra Bus 300er-400er Serie VA rechts	000 320 01 32 000 320 09 32 8.226.368.000	L=148	

PL-number	pf./ applicable for	OE-Ref.	Dimension	picture
015 300 007				
Koppelstange steering rod	Setra Bus 400er Serie HA	629 320 01 89	L=200	

PL-number	pf./ applicable for	OE-Ref.	Dimension	picture
015 400 000				
Koppelstange steering rod	Neoplan N318/ N516	N1.01101-5920	L=148 Konus=30	

PL-number	pf./ applicable for	OE-Ref.	Dimension	picture
015 400 001				
Koppelstange steering rod	Neoplan Centroliner VN8 Achse Starrachse RL85A	N1.01101.-5968	L=220 Konus=30	

PL-number	pf./ applicable for	OE-Ref.	Dimension	picture
015 400 002				
Koppelstange steering rod	Neoplan Renault Bus FR1/ Alliade Solaris	N1.01101-5861 5010013618 0807.101.60	L=120 Konus=30	

PL-number	pf./ applicable for	OE-Ref.	Dimension	picture
015 400 003				
Koppelstange steering rod	Renault Bus FR1/ Alliade	5010151410 5000786379 5000869762	L=120 Konus=30	

PL-number	pf./ applicable for	OE-Ref.	Dimension	picture
015 400 004				
Koppelstange steering rod	Renault Bus FR1/ Alliade	5010151409 5000869761	L=120 Konus=30	

PL-number	pf./ applicable for	OE-Ref.	Dimension	picture
015 500 900				
Koppelstange steering rod	Volvo Bus B7L/ B7L DD Volvo Bus B9TL/ B10L Volvo Bus B10B HA sowie NA/ axle Nr.2-3	3112282	L=220 Konus=30	

PL-number	pf./ applicable for	OE-Ref.	Dimension	picture
015 500 901				
Koppelstange steering rod	Volvo Truck FH12-16 Volvo Truck FM7-9-10-12	3986433 20477805 1629668	L=325 Konus=20 M18x1,5	

PL-number	pf./ applicable for	OE-Ref.	Dimension	picture
015 500 903				
Koppelstange steering rod	Volvo Truck FM7-10-12 Volvo Truck FH12-16	3987354	L=438 Konus=28,6 M20x1,5	

PL-number	pf./ applicable for	OE-Ref.	Dimension	picture
015 500 904				
Koppelstange steering rod	Volvo Bus B6R/ B7L Volvo Bus B7R/ B7L DD Volvo Bus B9L/ B12B-M Volvo Bus 8700 Scania Irizar PB14-16	9521922	L=150 Konus=28,6 M20x1,5	

PL-number	pf./ applicable for	OE-Ref.	Dimension	picture
015 503 900				
Koppelstange steering rod	Scania Bus Serie/mod.3 VA/ front axle	416159	L=210 Konus=20 M16x1,5	

PL-number	pf./ applicable for	OE-Ref.	Dimension	picture
015 503 901				
Koppelstange steering rod	Scania Bus Serie/mod.4 VA/ front axle	483527	L=284 Konus=26 M20x1,5	

PL-number	pf./ applicable for	OE-Ref.	Dimension	picture
015 503 902				
Koppelstange steering rod	Scania Bus Serie/mod.3 Scania Bus Serie/mod.4 VA/ front axle	445626 1766015	L=130 Konus=26 M20x1,5	

PL-number	pf./ applicable for	OE-Ref.	Dimension	picture
015 503 903				
Koppelstange steering rod	Scania Bus Serie/mod.3 Scania Bus Serie/mod.4 Scania Bus Serie F-K-N VA/ front axle	463245 1766014	L=100 Konus=26 M20x1,5	

PL-number	pf./ applicable for	OE-Ref.	Dimension	picture
015 503 904				
Koppelstange steering rod	Scania Bus Serie/mod.4 Scania Bus Serie F-K-N HA sowie NA/ axle Nr.2-3 links/ left	486590	L=160 Konus=26	

PL-number	pf./ applicable for	OE-Ref.	Dimension	picture
015 503 905				
Koppelstange steering rod	Scania Bus Serie/mod.4 Scania Bus Serie F-K-N HA sowie NA/ axle Nr.2-3 rechts/ right	488056	L=160 Konus=26	

PL-number	pf./ applicable for	OE-Ref.	Dimension	picture
015 503 906				
Koppelstange steering rod	Scania Bus Serie/mod.4 Scania Bus Serie F-K-N Scania Irizar PB12 links/ front axle left VA	1506925	L=150 Konus=26	

PL-number	pf./ applicable for	OE-Ref.	Dimension	picture
015 503 907				
Koppelstange steering rod	Scania Bus Serie/mod.4 Scania Irizar PB12 rechts/ front axle right VA	1506924	L=150 Konus=26	

PL-number	pf./ applicable for	OE-Ref.	Dimension	picture
015 503 908				
Koppelstange steering rod	Scania Bus Serie/mod.4 Scania Irizar front axle VA/	488739	L=145 Konus=26	

PL-number	pf./ applicable for	OE-Ref.	Dimension	picture
015 503 909				
Koppelstange steering rod	Scania Bus Serie/mod.4 Scania Bus Serie F-K-N Scania Irizar PB12 rear axle HA/	488738	L=293 Konus=30	

PROFILINE

KLEEMANN SPARE PARTS

PL-number	pf./ applicable for	OE-Ref.	Dimension	picture
015 503 910				
Koppelstange steering rod	Scania Bus Serie/mod.K Scania Irizar PB12	1451418 1455327 1751418 1789082	L=284 Konus=23 M20x1,5	









PL-number	pf./ applicable for	OE-Ref.	Dimension	picture

PL-number	pf./ applicable for	OE-Ref.	Dimension	picture

PL-number	pf./ applicable for	OE-Ref.	Dimension	picture

PL-number	pf./ applicable for	OE-Ref.	Dimension	picture

PL-number	pf./ applicable for	OE-Ref.	Dimension	picture

PL-number	pf./ applicable for	OE-Ref.	Dimension	picture
015 150 000				
Achsstrebe stabilizer link	MB Bus O405-407-408 HA unten rear axle below	357 350 03 06	L=585	
015 352 003				
Reparatursatz Achsstrebe repair kit (support joint)	015 150 000 (1x)	000 330 16 11	86,5x45x70 M24	
015 152 008				
Reparatursatz Achsstrebe repair kit (support joint)	015 150 000 (1x)	000 330 00 80	87x113x30x17	
015 150 001				
Achsstrebe stabilizer link	MB Bus O340 O405-407-408 VA längst/ front axle	357 330 31 11 322 330 10 11	L=775	
015 151 000				
Reparatursatz Achsstrebe repair kit (support joint)	015 150 001 (4x) 015 150 004 (4x) 015 150 005 (4x) 015 150 008 (2x)	317 333 11 64	AD=82 ID=55 H=40	
015 150 004				
Achsstrebe stabilizer link	MB Bus O407 (BM357) HA unten rear axle below	357 330 34 11 317 350 06 06	L=585	
015 150 005				
Achsstrebe stabilizer link	MB Bus O340-350 Tourismo	357 330 42 11 317 330 04 11	L=960	
015 150 008				
Achsstrebe stabilizer link	MB Bus O405-407-408 VA/ front axle	357 330 17 11	L=960	

PL-number	pf./ applicable for	OE-Ref.	Dimension	picture
015 152 005				
Reparatursatz Achsstrebe repair kit (support joint)	015 150 008 (1x) 015 150 009 (2x) 015 150 010 (2x) 015 150 011 (2x) 015 150 012 (2x) 015 150 012.1 (2x)	000 350 05 06	85x130x19x30	

PL-number	pf./ applicable for	OE-Ref.	Dimension	picture
015 150 009				
Achsstrebe stabilizer link	MB Bus O405-407-408 HA oben/ rear axle top	357 330 19 11 357 330 33 11	L=718	

PL-number	pf./ applicable for	OE-Ref.	Dimension	picture
015 150 010				
Achsstrebe stabilizer link	MB Bus Travego O580	629 350 01 06 629 350 11 06	L=725	

PL-number	pf./ applicable for	OE-Ref.	Dimension	picture
015 150 011				
Achsstrebe stabilizer link	MB Bus O405N HA oben/ rear axle top	357 333 09 05	L=662	

PL-number	pf./ applicable for	OE-Ref.	Dimension	picture
015 150 012				
Achsstrebe stabilizer link	MB Bus O340/ O350/ O530/ O540 O550/ O560/ O580 Setra 400er Serie	628 333 10 05 628 333 18 05	L=664	

PL-number	pf./ applicable for	OE-Ref.	Dimension	picture
015 150 012.1				
Achsstrebe stabilizer link	MB Bus O340/ O350/ O530/ O540 O550/ O560/ O580 Setra 400er Serie	628 333 09 05 628 333 17 05	L=576	

PL-number	pf./ applicable for	OE-Ref.	Dimension	picture
015 150 013				
Achsstrebe stabilizer link	MB Bus Citaro VA unten links front axle below left	628 333 02 05	L=659	

PL-number	pf./ applicable for	OE-Ref.	Dimension	picture
015 152 009				
Reparatursatz Achsstrebe repair kit (support joint)	015 150 013 (2x) 015 150 014 (2x)	000 330 21 11	67x115x24x17	

PL-number	pf./ applicable for	OE-Ref.	Dimension	picture
015 150 014				
Achsstrebe stabilizer link	MB Bus Citaro	628 333 03 05	L=659	

PL-number	pf./ applicable for	OE-Ref.	Dimension	picture
015 150 015				
Achsstrebe stabilizer link (L=806)	MB Bus Citaro VA längst/ front axle	628 333 01 01	L=806 Konus=48	

PL-number	pf./ applicable for	OE-Ref.	Dimension	picture
015 152 005				
Reparatursatz Achsstrebe repair kit (support joint)	015 150 015 (1x) 015 150 018 (1x)	000 350 05 06	85x130x19x30	

PL-number	pf./ applicable for	OE-Ref.	Dimension	picture
015 252 000				
Reparatursatz Achsstrebe repair kit (support joint)	015 150 015 (1x) 015 150 018 (1x)	000 330 01 07	D=85 L=250 Konus=48	

PL-number	pf./ applicable for	OE-Ref.	Dimension	picture
015 150 016				
Achsstrebe stabilizer link	MB Bus Citaro VA oben links front axle top left	628 333 04 05	L=618	

PL-number	pf./ applicable for	OE-Ref.	Dimension	picture
015 152 002				
Reparatursatz Achsstrebe repair kit (support joint)	015 150 016 (2x) 015 152 018 (1x)	000 350 05 11 000 330 22 11	67x130x19x24	

PL-number	pf./ applicable for	OE-Ref.	Dimension	picture
015 150 017				
Achsstrebe stabilizer link	MB Bus Citaro VA oben rechts front axle top right	628 333 05 05	L=618	

PL-number	pf./ applicable for	OE-Ref.	Dimension	picture
015 150 018				
Achstrebe stabilizer link	MB Bus O405 MB Bus Citaro VA quer/ front axle	357 333 01 01	L=806 Konus=48	

PL-number	pf./ applicable for	OE-Ref.	Dimension	picture
015 150 019				
Achstrebe stabilizer link	MB Truck MK-SK	385 350 00 06	L=500	

PL-number	pf./ applicable for	OE-Ref.	Dimension	picture
015 150 020				
Achsstrebe stabilizer link	MB Bus O405N VA oben/ front axle top	357 333 04 05	L=625	

PL-number	pf./ applicable for	OE-Ref.	Dimension	picture
015 251 000				
Reparatursatz Achsstrebe repair kit (support joint)	015 150 020 (2x)	357 330 00 35		

PL-number	pf./ applicable for	OE-Ref.	Dimension	picture
015 150 021				
Achsstrebe stabilizer link	MB Bus O405/ O405N MAN Bus EL-NL-NG	357 333 00 01 81.43230.6057	L=972 Konus=48	

PL-number	pf./ applicable for	OE-Ref.	Dimension	picture
015 252 000				
Reparatursatz Achsstrebe repair kit (support joint)	015 150 021 (1x)	000 330 01 07	D=85 L=250 Konus=48	

PL-number	pf./ applicable for	OE-Ref.	Dimension	picture
015 252 001				
Reparatursatz Achsstrebe repair kit (support joint)	015 150 021 (1x)	000 330 02 07 000 330 02 07	75x130x24x19	

PL-number	pf./ applicable for	OE-Ref.	Dimension	picture
015 150 023				
Achsstrebe stabilizer link	MB Bus O407	396 330 01 07	L=960 Konus=56	

PL-number	pf./ applicable for	OE-Ref.	Dimension	picture
015 150 024				
Achsstrebe stabilizer link	MB Bus O580 Setra S313-315UL Setra S315H/ S315NF	629 350 04 06	L=570	

PL-number	pf./ applicable for	OE-Ref.	Dimension	picture
015 152 005				
Reparatursatz Achsstrebe repair kit (support joint)	015 150 024 (2x)	000 350 05 06	85x130x19x30	

PL-number	pf./ applicable for	OE-Ref.	Dimension	picture
015 150 025				
Achsstrebe stabilizer link	MB Bus O350/ O404	356 330 02 11	L=769	

PL-number	pf./ applicable for	OE-Ref.	Dimension	picture
015 152 020				
Reparatursatz Achsstrebe repair kit (support joint)	015 150 025 (2x) 015 150 026 (1x)	000 350 13 05	75x130x17x24	









PL-number	pf./ applicable for	OE-Ref.	Dimension	picture
015 150 026				
Achsstrebe stabilizer link	MB Bus O350/ O404	356 350 01 06	L=628	

PL-number	pf./ applicable for	OE-Ref.	Dimension	picture
015 152 019				
Reparatursatz Achsstrebe repair kit (support joint)	015 150 026 (1x)	000 350 09 05	D=95 B=75 M24	

PL-number	pf./ applicable for	OE-Ref.	Dimension	picture
015 150 027				
Achsstrebe stabilizer link	MB Citaro HA oben links sowie rechts rear axle top left and right	628 333 01 05	L=576	

PL-number	pf./ applicable for	OE-Ref.	Dimension	picture
015 152 006				
Reparatursatz Achsstrebe repair kit (support joint)	015 150 027 (2x)	000 330 20 11	75x130x19x30	

PL-number	pf./ applicable for	OE-Ref.	Dimension	picture
015 150 030				
Achsstrebe stabilizer link	MB Bus O340-350-550-560-580 Setra Serie/mod. 400	629 350 12 06 629 350 28 05	L=628	

PL-number	pf./ applicable for	OE-Ref.	Dimension	picture
015 152 005				
Reparatursatz Achsstrebe repair kit (support joint)	015 150 030 (2x)	000 350 05 06	85x130x19x30	
PL-number	pf./ applicable for	OE-Ref.	Dimension	picture
015 150 031				
Achsstrebe stabilizer link	MB Truck NG-SK	624 350 01 06	L=579	
PL-number	pf./ applicable for	OE-Ref.	Dimension	picture
015 152 018				
Reparatursatz Achsstrebe repair kit (support joint)	015 150 018 (2x)	000 350 06 13	85x152x21x24	
PL-number	pf./ applicable for	OE-Ref.	Dimension	picture
015 150 032				
Achsstrebe stabilizer link	MB Truck	393 320 04 32	L=620	
PL-number	pf./ applicable for	OE-Ref.	Dimension	picture
015 131 004				
Reparatursatz Achsstrebe repair kit (support joint)	015 140 032 (2x)	000 350 02 13	80/65x24/21	
PL-number	pf./ applicable for	OE-Ref.	Dimension	picture
015 150 033				
Achsstrebe stabilizer link	MB Truck NG-SK	659 350 16 06	L=635	
PL-number	pf./ applicable for	OE-Ref.	Dimension	picture
015 152 017				
Reparatursatz Achsstrebe repair kit (support joint)	015 150 033 (2x)	000 350 01 13	108x152x21x24	
PL-number	pf./ applicable for	OE-Ref.	Dimension	picture
015 150 034				
Achsstrebe stabilizer link	MB Truck Actros MP1-2 Arocs/ Axor2/ Zetros	945 350 01 05 948 350 10 05 948 350 25 05	L=615	

PL-number	pf./ applicable for	OE-Ref.	Dimension	picture
015 152 022				
Reparatursatz Achsstrebe repair kit (support joint)	015 150 034 (2x)	000 350 27 05	85x152x21x24	

PL-number	pf./ applicable for	OE-Ref.	Dimension	picture
015 150 035				
Achsstrebe stabilizer link	MB Truck Actros MP1-2 MB Truck Atego	948 350 08 05 948 350 19 05 947 350 06 05	L=565	

PL-number	pf./ applicable for	OE-Ref.	Dimension	picture
015 152 015				
Reparatursatz Achsstrebe repair kit (support joint)	015 150 035 (2x)	000 350 26 05	75x152x24x21	

PL-number	pf./ applicable for	OE-Ref.	Dimension	picture
015 150 036				
Achsstrebe stabilizer link	MB NG-SK	393 320 01 32 655 350 00 06 658 350 02 06	L=585	

PL-number	pf./ applicable for	OE-Ref.	Dimension	picture
015 152 018				
Reparatursatz Achsstrebe repair kit (support joint)	015 150 036 (2x)	000 350 06 13 000 586 11 35	85x152x21x24	

PL-number	pf./ applicable for	OE-Ref.	Dimension	picture
015 150 037				
Achsstrebe stabilizer link	MB Bus Travego O580	627 350 01 06	L=658	

PL-number	pf./ applicable for	OE-Ref.	Dimension	picture
015 152 005				
Reparatursatz Achsstrebe repair kit (support joint)	015 150 037 (2x) 015 150 038 (2x) 015 150 039 (2x)	000 350 05 06	85x130x19x30	

PL-number	pf./ applicable for	OE-Ref.	Dimension	picture
015 150 038				
Achsstrebe stabilizer link	MB Bus Travego O580	629 350 06 06	L=658	

PL-number	pf./ applicable for	OE-Ref.	Dimension	picture
015 150 039				
Achsstrebe stabilizer link (L=750)	MB Bus Travego O580	627 350 03 06	L=750	

PL-number	pf./ applicable for	OE-Ref.	Dimension	picture
015 180 000				
Achsstrebe stabilizer link	Bova HA/ rear axle	186782 450401 20233046 233046	L=700	

PL-number	pf./ applicable for	OE-Ref.	Dimension	picture
015 152 005				
Reparatursatz Achsstrebe repair kit (support joint)	015 180 000 (2x) 015 180 0 01 (2x)	000 350 05 06	85x130x19x30	









PL-number	pf./ applicable for	OE-Ref.	Dimension	picture
015 180 001				
Achsstrebe stabilizer link	Bova HA/ rear axle	186781 20233047 233047	L=700	









PL-number	pf./ applicable for	OE-Ref.	Dimension	picture
015 180 100				
Achsstrebe stabilizer link	Solaris Urbino12-18 Solaris Vacanza 13 HA	0820.300.220 0870.317.324	L=455	







PL-number	pf./ applicable for	OE-Ref.	Dimension	picture
015 252 009				
Reparatursatz Achsstrebe repair kit (support joint)	015 180 100 (2x)	0827 566 11 1101 596 4	85x130x21x30	









PL-number	pf./ applicable for	OE-Ref.	Dimension	picture
015 250 005				
Achsstrebe stabilizer link	MAN Truck TGA-TGS-TGX	81.43220.6267 81.43220.6020 81.43220.6229	L=572	

PL-number	pf./ applicable for	OE-Ref.	Dimension	picture
015 252 003				
Reparatursatz Achsstrebe repair kit (support joint)	015 250 005 (2x)	81.43220.6132	72x166x30x19	

PL-number	pf./ applicable for	OE-Ref.	Dimension	picture
015 250 007				
Achsstrebe stabilizer link	MB Bus O405 MAN Bus E L/ NG/ NL	357 333 02 05 81.43220.6185	L=750	
015 252 019				
Reparaturatz Achsstrebe repair kit (support joint)	015 250 007 (2x) 015 250 010 (2x)	81.43270.6127	85x170x30x19	
015 250 008				
Achsstrebe stabilizer link	MAN Bus NL-NM-NÜ Neoplan Centroliner N4516	81.43220.6145 81.43220.6209 81.43220.6160	L=531	
015 152 005				
Reparaturatz Achsstrebe repair kit (support joint)	015 152 005 (2x)	81.43220.6055	85x130x19x30	
015 250 009				
Achsstrebe stabilizer link	MAN Bus LionsCity MAN Bus NG-NL-NM-NÜ Neoplan N4516-20-21-22	81.43220.6164	L=413	
015 250 010				
Achsstrebe stabilizer link (L=750)	MB Bus O405 MAN Bus EL/ NG/ NL	357 333 02 05 81.43220.6173	L=750	
015 250 011				
Achsstrebe stabilizer link	MAN Bus LionsClassic A51-54-55-56-59-61-72-75 A85-90	81.43220.6125	L=630	
015 152 005				
Reparaturatz Achsstrebe repair kit (support joint)	015 250 011 (2x)	81.43220.6055	85x130x19x30	

PL-number	pf./ applicable for	OE-Ref.	Dimension	picture
015 252 020				
Reparatursatz Achsstrebe repair kit (support joint)	015 250 011 (2x)	81.43220.6204	95/78x72/53x48 M24x2	
015 250 012				
Achsstrebe stabilizer link	MAN Bus ÜL LionsStar-Coach Neoplan N1216/ N2216 Neoplan N3516/ N4516	81.43220.6183 81.43220.6277 81.43220.6151	L=570	
015 152 005				
Reparatursatz Achsstrebe repair kit (support joint)	015 250 012 (2x)	81.43220.6055	85x130x19x30	
015 250 013				
Achsstrebe stabilizer link	MAN Bus ÜL LionsStar-Coach Neoplan N1216/ N2216 Neoplan N3516	81.43220.6178 81.43220.6225 81.43220.6180	L=470	
015 250 014				
Achsstrebe stabilizer link	MAN Truck TGA-TGS-TGX	81.43220.6247 81.43220.6341 81.43220.6342	L=414	
015 250 016				
Achsstrebe stabilizer link	MAN Truck TGA E2000/ F2000/ M2000 F90/ M90	81.43220.6129 81.43220.6096 81.43230.6014	L=571	
015 250 017				
Achsstrebe stabilizer link	MAN Bus ÜL242-272-292-312-322	81.43230.6058	L=777	
015 250 018				
Achsstrebe stabilizer link	MAN Bus ÜL LionsCaoch/ LionsStar	81.43220.6187	L=633	

PL-number	pf./ applicable for	OE-Ref.	Dimension	picture
015 152 005				
Reparatursatz Achsstrebe repair kit (support joint)	015 250 018 (1x) 015 250 020 (2x) 015 250 021 (2x)	81.43220.6055	85x130x19x30	
015 252 020				
Reparatursatz Achsstrebe repair kit (support joint)	015 250 018 (1x)	81.43220.6204	95/78x72 53x48 M24x2	
015 250 019				
Achsstrebe stabilizer link	MAN LionsCity NG/ NL/ NM/ ND/ NÜ Neoplan N4516-20-21-22	81.43220.6215 81.43220.6166 81.43220.6227	L=413	
015 250 020				
Achsstrebe stabilizer link (L=532)	MAN Bus NG/ NL/ NM/ NÜ MAN Truck TGA-TGX Neoplan N4516	81.43220.6190 81.43220.6161	L=532	
015 250 021				
Achsstrebe stabilizer link	MAN Bus NG/ NL/ NM/ NÜ SD202 Neoplan N4616	81.43220.6189 81.43220.6144 81.43220.6189	L=614	
015 250 022				
Achsstrebe stabilizer link	MAN Truck TGA-TGS-TGX	81.43220.6270	L=572	
015 152 006				
Reparatursatz Achsstrebe repair kit (support joint)	015 250 022 (2x)	85.43220.6002	75x130x19x30	
015 250 023				
Achsstrebe stabilizer link	MAN Truck TGA-TGS	82.43220.6008	L=585	

PL-number	pf./ applicable for	OE-Ref.	Dimension	picture
015 252 016				
Reparaturatz Achsstrebe repair kit (support joint)	015 250 023 (2x)	81.43220.6241	95x130x21x35	
PL-number	pf./ applicable for	OE-Ref.	Dimension	picture
015 250 028				
Achsstrebe stabilizer link	MAN Bus ÜL LionsStar/ LionsCoach Neoplan N2216/ N3516	81.43220.6224 81.43220.6179 81.43220.6177	L=330	
PL-number	pf./ applicable for	OE-Ref.	Dimension	picture
015 252 022				
Reparaturatz Achsstrebe repair kit (support joint)	015 250 028 (1x)		DA=67 B1=115/ B2=35	
PL-number	pf./ applicable for	OE-Ref.	Dimension	picture
015 252 023				
Reparaturatz Achsstrebe repair kit (support joint)	015 250 028 (1x)		DA=67,5 L=83,5 M16x1,5	
PL-number	pf./ applicable for	OE-Ref.	Dimension	picture
015 250 030				
Achsstrebe stabilizer link	MAN Bus LionsCoach/ LionsStar	81.43315.6034	L=415	
PL-number	pf./ applicable for	OE-Ref.	Dimension	picture
015 250 032				
Achsstrebe stabilizer link	MAN Bus LionsClassic/ LionsCity	81.43220.6220	L=630	
PL-number	pf./ applicable for	OE-Ref.	Dimension	picture
015 152 005				
Reparaturatz Achsstrebe repair kit (support joint)	015 250 032 (1x) 015 250 033 (2x)	81.43220.6055	85x130x19x30	
PL-number	pf./ applicable for	OE-Ref.	Dimension	picture
015 252 020				
Reparaturatz Achsstrebe repair kit (support joint)	015 250 018 (1x)	81.43220.6204	95/78x72 53x48 M24x2	

PL-number	pf./ applicable for	OE-Ref.	Dimension	picture
015 250 033				
Achsstrebe stabilizer link	MAN Bus SD200-SD202	81.43220.6080 81.43220.6032 81.43220.6087	L=522	

PL-number	pf./ applicable for	OE-Ref.	Dimension	picture
015 252 002				
Reparatursatz Achsstrebe repair kit (support joint)	015 250 033 (2x)	81.43220.6104	85x130x30x19	

PL-number	pf./ applicable for	OE-Ref.	Dimension	picture
015 250 034				
Achsstrebe stabilizer link	MAN Truck TGA-TGS-TGX	81.43220.6222 81.43220.6260 81.32220.6283	L=941	

PL-number	pf./ applicable for	OE-Ref.	Dimension	picture
015 252 018				
Reparatursatz Achsstrebe repair kit (support joint)	015 250 034 (2x)	81.43220.6244	75x115x24x17	

PL-number	pf./ applicable for	OE-Ref.	Dimension	picture
015 250 035				
Achsstrebe stabilizer link	MAN Truck TGA-TGS-TGX	81.43220.6268 81.43220.6291	L=572	

PL-number	pf./ applicable for	OE-Ref.	Dimension	picture
015 152 006				
Reparatursatz Achsstrebe repair kit (support joint)	015 250 035 (2x)	85.43220.6002	75x130x19x30	

PL-number	pf./ applicable for	OE-Ref.	Dimension	picture
015 350 000				
Achsstrebe stabilizer link	Setra S215HD	8.226.241.000	L=660	

PL-number	pf./ applicable for	OE-Ref.	Dimension	picture
015 152 005				
Reparatursatz Achsstrebe repair kit (support joint)	015 350 000 (1x) 015 350 001 (2x) 015 350 002 (2x)	81.43220.6055	85x130x19x30	

PL-number	pf./ applicable for	OE-Ref.	Dimension	picture
015 351 000				
Reparatursatz Achsstrebe repair kit (support joint)	015 350 000 (2x)	4.771.347.000	DA=85 DI=60 H=46,5	
015 350 001				
Achsstrebe stabilizer link	Setra	8.226.318.000 8.226.323.000	L=660	
015 350 002				
Achsstrebe stabilizer link	Setra	8.226.387.000	L=660	
015 352 002				
Reparatursatz Achsstrebe repair kit (support joint)	015 350 002 (2x) Setra 300er Serie Euro2	000 352 01 27	90x130x19x30	
015 152 005				
Reparatursatz Achsstrebe repair kit (support joint)	015 300 002 (2x) Setra 300er ab Euro3	81.43220.6055	85x130x19x30	
015 450 000				
Achsstrebe stabilizer link	Neoplan	N1.01101-5875	L=650	
015 152 005				
Reparatursatz Achsstrebe repair kit (support joint)	015 450 000 (1x)	81.43220.6055	85x130x19x30	
015 452 001				
Reparatursatz Achsstrebe repair kit (support joint)	015 450 000 (1x)	0827 510 27	D=95 H=72 M24x1,5	

PL-number	pf./ applicable for	OE-Ref.	Dimension	picture
015 450 001				
Achsstrebe stabilizer link	Neoplan	N1.01101.5884	L=540	

PL-number	pf./ applicable for	OE-Ref.	Dimension	picture
015 252 005				
Reparatursatz Achsstrebe repair kit (support joint)	015 450 001 (1x)	81.43230.6051	75x115x24x17	

PL-number	pf./ applicable for	OE-Ref.	Dimension	picture
015 450 002				
Achsstrebe stabilizer link	Neoplan Centroliner N4516/ 4520 Längslenker unten	N1.01101-5955	L=455	

PL-number	pf./ applicable for	OE-Ref.	Dimension	picture
015 452 007				
Reparatursatz Achsstrebe repair kit (support joint)	015 450 002 (2x)	1376728	75x130x24x21	

PL-number	pf./ applicable for	OE-Ref.	Dimension	picture
015 450 003				
Achsstrebe stabilizer link	Neoplan Centroliner N4516/ 4520 Längslenker oben	1101 595 4 0827 563 20	L=480	

PL-number	pf./ applicable for	OE-Ref.	Dimension	picture
015 252 011				
Reparatursatz Achsstrebe repair kit (support joint)	015 450 003 (2x)	81.43220.6202	67x100x17x24	

PL-number	pf./ applicable for	OE-Ref.	Dimension	picture
015 450 005				
Achsstrebe stabilizer link	Neoplan N316 HA	36.43250.6001 1101 353 4	L=1080	

PL-number	pf./ applicable for	OE-Ref.	Dimension	picture
015 152 005				
Reparatursatz Achsstrebe repair kit (support joint)	015 450 005 (1x) 015 450 009 (1x)	81.43220.6055	85x130x19x30	

PL-number	pf./ applicable for	OE-Ref.	Dimension	picture
015 450 009				
Achsstrebe stabilizer link	Neoplan	N1.01101-5879	L=650	
015 452 001				
Reparatursatz Achsstrebe repair kit (support joint)	015 450 009 (1x)	0827 510 27	D=95 H=72 M24x1,5	
015 450 010				
Achsstrebe stabilizer link	MAN Bus LionsCoach LionsRegio/ LionsCity Neoplan Centroliner Cityliner/ Tourliner Trendliner/ Starliner Scania Irizar PB14	81.43220.6275 81.43220.6258 81.43220.6279 81.43220.6278 81.43220.6264	L=688	
015 252 019				
Reparatursatz Achsstrebe repair kit (support joint)	015 450 010 (2x)	81.43270.6127	85x170x30x19	
015 450 011				
Achsstrebe stabilizer link	Neoplan HA	81.43220.6299	L=270	
015 450 012				
Achsstrebe stabilizer link	Neoplan	N1.01101-5935	L=660	
015 451 002				
Gummiring für Achsstrebe an Vorderachse Bushing for stabilizer link front axle	Neoplan N414-N4016	N1.01101-3480	konisch	

PL-number	pf./ applicable for	OE-Ref.	Dimension	picture
015 452 000				
Reparatursatz Achsstrebe repair kit (support joint)	Neoplan N316 HA ZF Hinterachse Dreieckslenker Solaris	N1.01101-3543	L=160 LA=130/ D=19 M38 Rechtsgewinde	

PL-number	pf./ applicable for	OE-Ref.	Dimension	picture
015 452 002				
Reparatursatz Achsstrebe repair kit (support joint)	Neoplan	N1.01101-5867	L=160 LA=130/ D=21 M38 Linksgewinde	

PL-number	pf./ applicable for	OE-Ref.	Dimension	picture
015 452 003				
Reparatursatz Achsstrebe repair kit (support joint)	Neoplan	N1.01101-5865	D=85/ B=130 L=160/ LA=230 M38 Rechtsgewinde	

PL-number	pf./ applicable for	OE-Ref.	Dimension	picture
015 452 004				
Reparatursatz Achsstrebe repair kit (support joint)	Neoplan	N1.01101-5857	L=150 LA=100/ D=17 M30 Linksgewinde	

PL-number	pf./ applicable for	OE-Ref.	Dimension	picture
015 452 005				
Reparatursatz Achsstrebe repair kit (support joint)	Neoplan	N1.01101-5858	L=150 IA=100/ D=17 M30 Rechtsgewinde	

PL-number	pf./ applicable for	OE-Ref.	Dimension	picture
015 152 010				
Reparatursatz Achsstrebe repair kit (support joint)	Neoplan	1101 568 6	L=115 Konus=26 M30x1,5	

PL-number	pf./ applicable for	OE-Ref.	Dimension	picture
015 500 000				
Achsstrebe stabilizer link	Volvo Truck FH12-16/ FM9-12/ FL6	1626958 Volvo	L=571	

PL-number	pf./ applicable for	OE-Ref.	Dimension	picture
015 252 009				
Reparatursatz Achsstrebe repair kit (support joint)	015 500 000 (2x)	273373 Volvo 274019 Volvo	85x130x21x30	

PL-number	pf./ applicable for	OE-Ref.	Dimension	picture
015 500 001				
Achsstrebe stabilizer link	Volvo Truck FL6/ FH FM/ FH12-16/ FM9-12 Volvo Bus B6R/ B7R	20517494 Volvo	L=625	

PL-number	pf./ applicable for	OE-Ref.	Dimension	picture
015 252 018				
Reparatursatz Achsstrebe repair kit (support joint)	015 500 001 (2x)	3093462 Volvo 85104224 Volvo	75x115x24x17	

PL-number	pf./ applicable for	OE-Ref.	Dimension	picture
015 500 002				
Achsstrebe stabilizer link (L=666)	Volvo Truck F10-12-16 Volvo Truck FL6-7-10-12 Volvo Bus B7R	1082104 Volvo 1605035 Volvo	L=666	

PL-number	pf./ applicable for	OE-Ref.	Dimension	picture
015 500 500				
Reparatursatz Achsstrebe repair kit (support joint)	015 500 002 (1x) 015 500 003 (1x)	1598588 Volvo	91/14x125x30	

PL-number	pf./ applicable for	OE-Ref.	Dimension	picture
015 551 000				
Reparatursatz Achsstrebe repair kit (support joint)	015 500 002 (1x) 015 500 003 (1x)	1135080 Volvo	DI=52 DA=92 L=74-85	

PL-number	pf./ applicable for	OE-Ref.	Dimension	picture
015 500 003				
Achsstrebe stabilizer link	Volvo Bus B10B-M-R Volvo Bus B12-12R	1135429 Volvo 8365399 Volvo	L=510	

PROFILINE

KLEEMANN SPARE PARTS

PL-number	pf./ applicable for	OE-Ref.	Dimension	picture
015 500 004				
Achsstrebe stabilizer link	Volvo Truck F10-12-16 Volvo Truck FL7-10-12 Volvo Bus B10B/ B10M Volvo Bus B12BR/ B58	1589817 Volvo	L=666	

PL-number	pf./ applicable for	OE-Ref.	Dimension	picture
015 500 500				
Reparatursatz Achsstrebe repair kit (support joint)	015 500 004 (2x)	1598588 Volvo	91/14x125x30	

PL-number	pf./ applicable for	OE-Ref.	Dimension	picture
015 500 005				
Achsstrebe stabilizer link	Volvo Truck FM9-12	20443046 Volvo	L=575	

PL-number	pf./ applicable for	OE-Ref.	Dimension	picture
015 252 018				
Reparatursatz Achsstrebe repair kit (support joint)	015 500 005 (2x)	3093462 85104224	75x115x24x17	

PL-number	pf./ applicable for	OE-Ref.	Dimension	picture
015 500 006				
Achsstrebe stabilizer link	Volvo Truck FL6	8074268	L=575	

PL-number	pf./ applicable for	OE-Ref.	Dimension	picture
015 252 011				
Reparatursatz Achsstrebe repair kit (support joint)	015 500 006 (2x)	275988	67x100x17x24	

PL-number	pf./ applicable for	OE-Ref.	Dimension	picture
015 500 007				
Achsstrebe stabilizer link	Volvo Truck FH/ FM Volvo Truck FH12-16 Volvo Truck FM7-9-10-12	21106157 20410053	L=799	

PL-number	pf./ applicable for	OE-Ref.	Dimension	picture
015 252 018				
Reparatursatz Achsstrebe repair kit (support joint)	015 500 007 (2x)	3093462 85104224	75x115x24x17	

PL-number	pf./ applicable for	OE-Ref.	Dimension	picture
015 501 000				
Achsstrebe stabilizer link	Iveco Truck EuroStar-Tech-Trakker	41009661	L=595	

PL-number	pf./ applicable for	OE-Ref.	Dimension	picture
015 252 002				
Reparatursatz Achsstrebe repair kit (support joint)	015 501 000 (2x)	93192361	75x130x24x19	

PL-number	pf./ applicable for	OE-Ref.	Dimension	picture
015 501 001				
Achsstrebe stabilizer link	Iveco Truck EuroTrakker	42065332	L=610	

PL-number	pf./ applicable for	OE-Ref.	Dimension	picture
015 241 000				
Reparatursatz Achsstrebe repair kit (support joint)	015 501 001 (2x)	042493431	95x152x21x24	









PL-number	pf./ applicable for	OE-Ref.	Dimension	picture
015 503 000				
Achsstrebe stabilizer link	Scania Truck Serie/mod.4 Serie/mod. P-G-R-T	2097845 2195678 2291687	L=552	

PL-number	pf./ applicable for	OE-Ref.	Dimension	picture
015 152 009				
Reparatursatz Achsstrebe repair kit (support joint)	015 503 000 (2x)	550800	67x115x24x17	

PL-number	pf./ applicable for	OE-Ref.	Dimension	picture
015 503 001				
Achsstrebe stabilizer link	Scania Truck Serie/mod.3-4 Serie/mod. P-G-R-T	1399180	L=568	

PL-number	pf./ applicable for	OE-Ref.	Dimension	picture
015 252 005				
Reparatursatz Achsstrebe repair kit (support joint)	015 503 001 (2x)	639370 1104334	75x115x24x17	

PL-number	pf./ applicable for	OE-Ref.	Dimension	picture
015 503 002				
Achsstrebe stabilizer link	Scania Truck Serie/mod.3-4 Serie/mod. P-G-R-T Bus Serie/mod.F-K-N	1428347	L=568	
015 152 009				
Reparatursatz Achsstrebe repair kit (support joint)	015 503 002 (2x) 015 503 002 (2x)	550800	67x115x24x17	
015 503 003				
Achsstrebe stabilizer link	Scania Truck Serie/mod.3-4 Serie/mod. P-G-R-T Bus Serie/mod.F-K-N	1428349 1326775	L=552	
015 503 004				
Achsstrebe stabilizer link	Scania Truck Serie/mod.4 Serie/mod.P-G-R-T	1486757 1485758	L=568	
015 503 505				
Reparatursatz Achsstrebe repair kit (support joint)	015 503 004 (2x)	1498131	D=67/ LA=115 L=19/ D=19	
015 503 005				
Achsstrebe stabilizer link	Scania Truck Serie/mod.4 Serie/mod.P-G-R-T	1485759	L=552	
015 331 015				
Reparatursatz Achsstrebe repair kit (support joint)	015 503 005 (2x)	1498132	75x115x19x24	
015 503 006				
Achsstrebe stabilizer link	Scania Truck Serie/mod.4 Serie/mod.P-G-R-T	1499478 1485760 1722750	L=615	

PL-number	pf./ applicable for	OE-Ref.	Dimension	picture
015 252 012				
Reparatursatz Achsstrebe repair kit (support joint)	015 503 006 (2x)	1515981	75x115x19x30	
015 526 000				
Achsstrebe stabilizer link	Daf Truck 75CF/ CF75 daf Truck CF85/ 85FTG VA/ front axle	1294251	L=690	
015 252 021				
Reparatursatz Achsstrebe repair kit (support joint)	015 526 000 (2x)	1294251	67x130x24x19	
015 526 001				
Achsstrebe stabilizer link	Daf Truck CF75/ CF85 Daf Truck XF95/ XF105	1261101	L=390	
015 131 004				
Reparatursatz Achsstrebe repair kit (support joint)	015 526 001 (1x)	0693778	80/65x24/21	
015 526 503				
Reparatursatz Achsstrebe repair kit (support joint)	015 526 001 (1x)	1271124	72/65x166x19	
015 526 002				
Achsstrebe stabilizer link	Daf Truck 65-75-85CF Daf Truck 95XF/ LF55 Daf Truck CF65-75-85 Daf Truck XF95/ XF105	0267743 267743 1361649	L=611	
015 252 009				
Reparatursatz Achsstrebe repair kit (support joint)	015 526 002 (2x)	0513757 0691709	85x130x21x30	

PL-number	pf./ applicable for	OE/ OEM-Ref.	Dimension	picture
015 221 000				
Gummibuchse VA Innen Bushing front axle inside	MAN Bus SL-SÜ-SR-SG	81.43271.0033	DA=75/ DI=55/ H=83	
015 221 001				
Gummibuchse VA Außen Bushing front axle outside	MAN Bus SL-SÜ-SR-SG	81.44204.0021	DA=68/ DI=58/ H=80	
015 221 002				
Bolzen VA Innen Bold front axle inside	MAN Bus (BM V7-70SL..)	81.91020.0337	L1=194/ L2=150 DA=55/ LG=60 IG=M14x1,5	
015 221 003				
Bolzen VA Außen Bold front axle outside	MAN Bus (BM V7-70SL..)	81.91020.0646	L=174 DA1=58/ DA2=56 IG=M27x2,0	
015 221 004				
Bolzen VA Außen Bold front axle outside	MAN Bus Bj.ab 04/85	81.91020.0586	L=174 D1=58/ D2=40 IG=M20x1,5	
015 221 006				
Gummibuchse VA Außen Bushing front axle outside	MAN Bus SL-SÜ-SR-SG	81.43271.0074	DA=68/ DI=42/ H=69	
015 221 007				
Bolzen VA Außen Bold front axle outside	MAN Bus mit Achsen V7-70SL00 01/14/15/23/24	81.91020.0277	L=173 DA1=42/ DA2=40 IG=M20x2	
015 221 009				
Gummibuchse Vorderachse Bushing front axle	MAN Bus	81.44204.0012 81.44204.0004	DA=68/ DI=42/ H=68	

Fahrwerk Einzelradaufhängung Vorderachse Setra 200er/ 300er Serie Independent Suspension front axle Setra







B2
repair set with
A2-A3-A4-A5

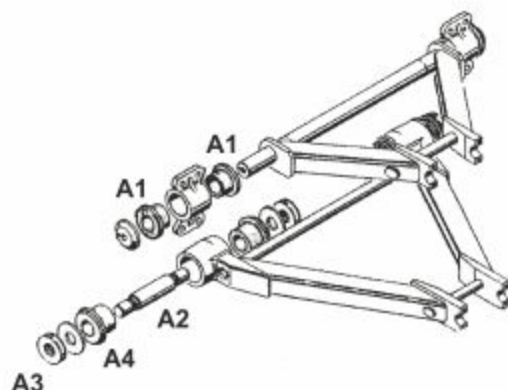

B1



PL-number	pf./ applicable for	picture	Dimension	picture
015 331 002				
Gummibuchse Bushing	Dreieckslenker VA oben delta guider front axle top	A1	DA=80 DI=64 L=50,5	
015 331 031K				
Reparatursatz Repair-Set	Dreieckslenker VA oben delta guider front axle top	B1		Bild siehe oben picture above
015 331 003				
Bolzen/ Bold	Dreieckslenker VA unten delta guider front axle below	A2	L=232 DA=45 AG=M38x2	
015 331 004				
Kreuzlochmutter Cross Hole Nut	Dreieckslenker VA unten delta guider front axle below	A3	DA=80 B=16 M36x1,5	
015 331 017				
Gummibuchse Bushing	Dreieckslenker VA unten delta guider front axle below	A4	DA=95 DI=46 L=67	
015 331 030				
Reparatursatz Repair-Set	Dreieckslenker VA unten (A1+A2+A3+A4) delta guider front axle below	B2		Bild siehe oben picture above

Fahrwerk-Hinterachsfahrschemel Setra 200er/ 300er Serie Hinterachse A-Arm Rear Axle

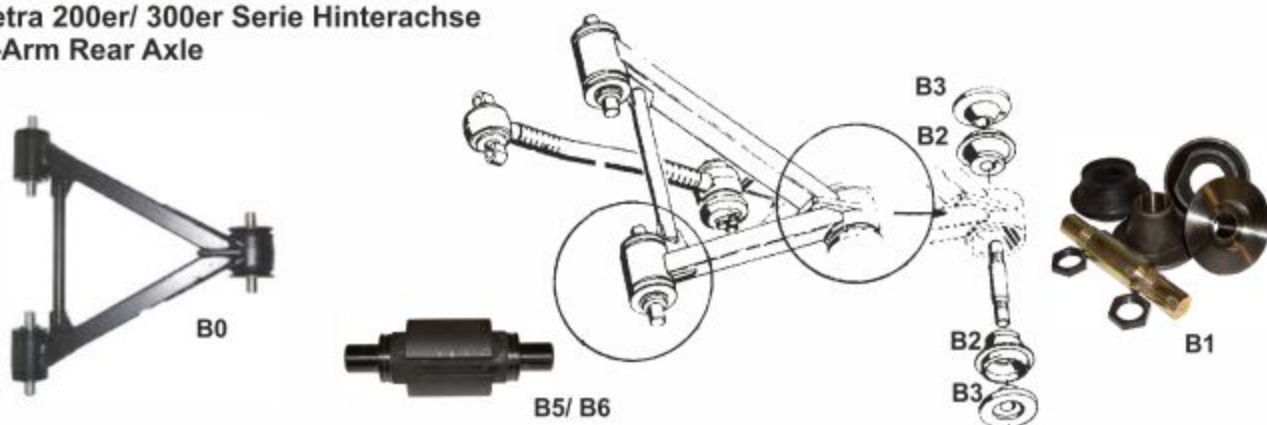

PL-number	pf./ applicable for	Dimension	picture	
015 340 000				
Dreieckslenker Hinterachs- fahrschemel	Setra Serie/mod. 200-300 Fahrschemel HA/ delta guider rear axle	B0	Bild siehe oben Picture look above	
PL-number	pf./ applicable for	Dimension	picture	
015 341 009				
Reparatursatz Repair-Set	Setra Serie/mod. 200-300 Fahrschemel HA/ delta guider rear axle	B1	Bild siehe oben Picture look above	
PL-number	pf./ applicable for	picture	Dimension	picture
015 341 007				
Konusbuchse Bushing	Für Spitze des Dreieckslenkers (es werden 2 Stück benötigt) top from the delta guider on rear axle	B2	DA=85 DI=56 H=65	
PL-number	pf./ applicable for	picture	Dimension	picture
015 341 008				
Distanzplatte Spacer Plate	Für Spitze des Dreieckslenkers (es werden 2 Stück benötigt) top from the delta guider on rear axle	B3	L=68 DI1=45 DI2=36	
PL-number	pf./ applicable for	picture	Dimension	picture
015 341 002				
Buchsenhälfte Bushing	Setra Serie/mod. 200-300 Fahrschemel HA/ delta guider rear axle	B5	DA=82 DI=61 L=137 H=100	
PL-number	pf./ applicable for	picture	Dimension	picture
015 341 001				
Bolzen/ Bold	Setra Serie/mod. 200-300 Fahrschemel HA/ delta guider rear axle	B6	L=252 DA1=60 DA2=35	

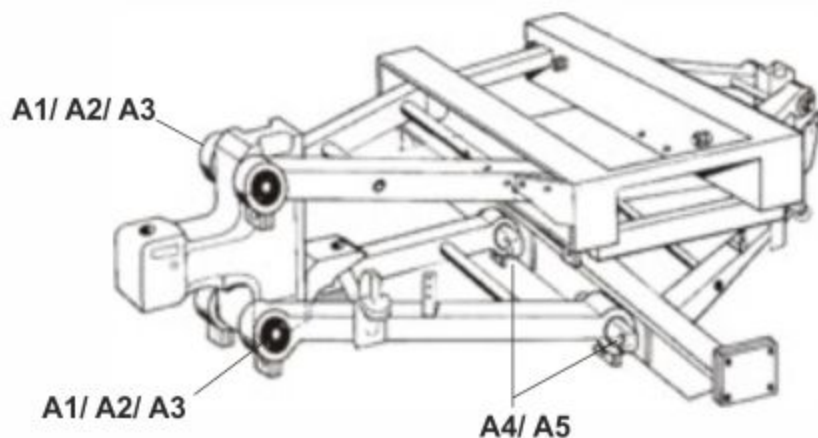

PL-number	pf./ applicable	Picture	OE/ OEM-Ref.	Dimension	picture
015 431 000					
Buchse außen Bushing outside	VN8 Achse/ Axle	A1	N1.01101-5005	DA=64 DI=36 L=76	
015 431 002					
Bolzen außen Bold outside	VN8 Achse/ Axle	A2	N1.01101-5327	L=310 coarse thread	
015 431 004					
Mutter außen Nut outside	VN8 Achse/ Axle	A3	N1.01101-5002	M30 self lock	
915 431 006					
Buchse innen Bushing inside	VN8 Achse/ Axle	A4	N1.01101-5004	D=64 L=165/ 75	
015 431 008					
Bolzen innen Bold inside	VN8 Achse/ Axle	A5	N1.01105-5310	M18x210 DIN931	

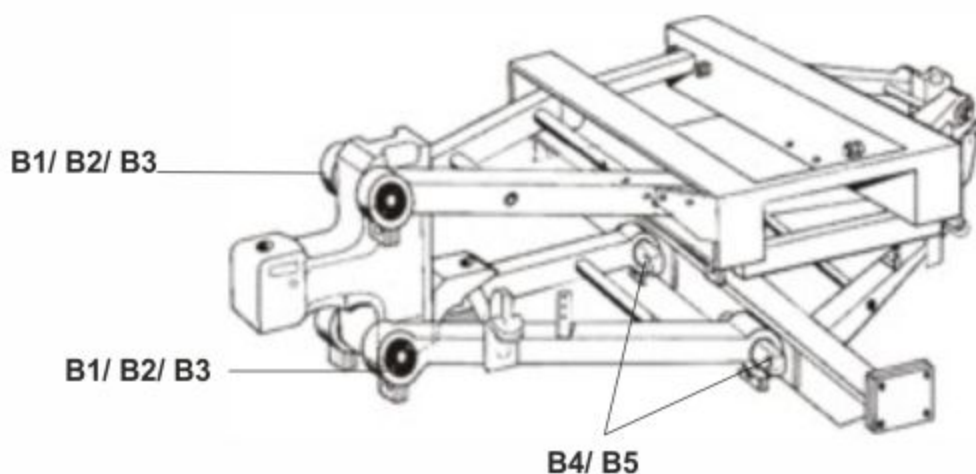

PL-number	pf./ applicable	Picture	OE/ OEM-Ref.	Dimension	picture
015 431 001					
Buchse außen Bushing outside	VN9 Achse/ Axel	B1	1101 568 7	DA=78 DI=30 H=78	
015 431 003					
Bolzen außen Bold outside	VN9 Achse/ Axel	B2	1101 568 8	L=270 M30x2	
015 431 005					
Mutter außen Nut outside	VN9 Achse/ Axel	B3	N1.01105-6426	M30 fine thread	
015 431 007					
Buchse innen Bushing inside	VN9 Achse/ Axel	B4	1101 500 9	D=64 L=160/ 85	
015 431 008					
Bolzen innen Bold inside	VN9 Achse/ Axel	B5	N1.01105-5310	M18x210 DIN931	

Fahrwerk Hinterachsfahrschemel / Subframe Suspension Neoplan

Version 1/ old Neoplan bus

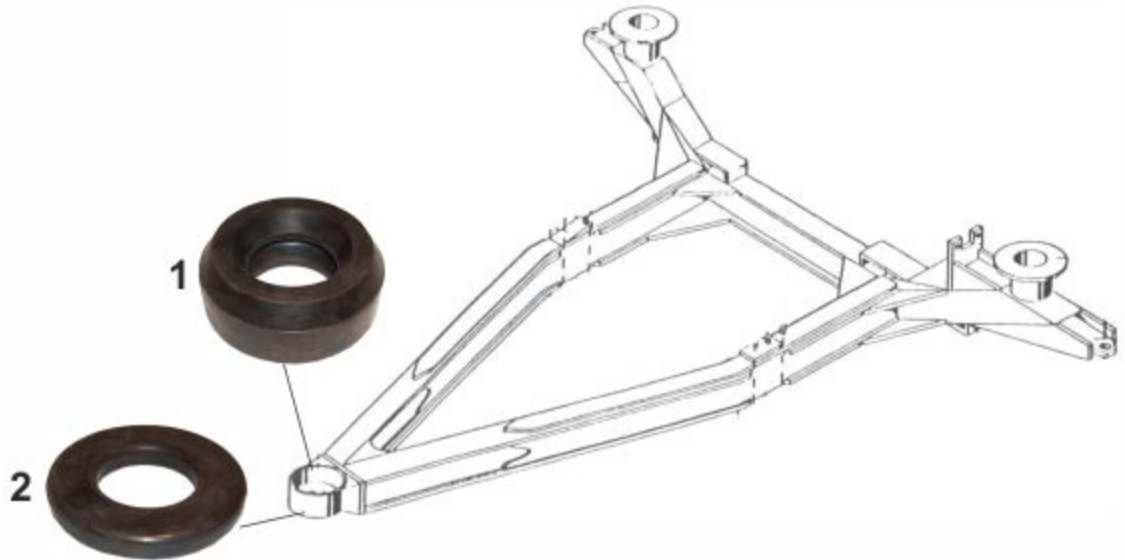

PL-number	pf./ applicable	Picture	OE/ OEM-Ref.	Dimension
015 441 002				
Fahrschemellager Subframe mounting	Neoplan	1	N1.01101-3470	DA=200/ DI=100/ H=80

PL-number	pf./ applicable	Picture	OE/ OEM-Ref.	Dimension
015 441 010				
Fahrschemellager Subframe mounting	Neoplan	2	N1.01101-3474 N1.01101-3475	DA=200/ DI=100/ H=13

Version 1/ old Neoplan Skyliner

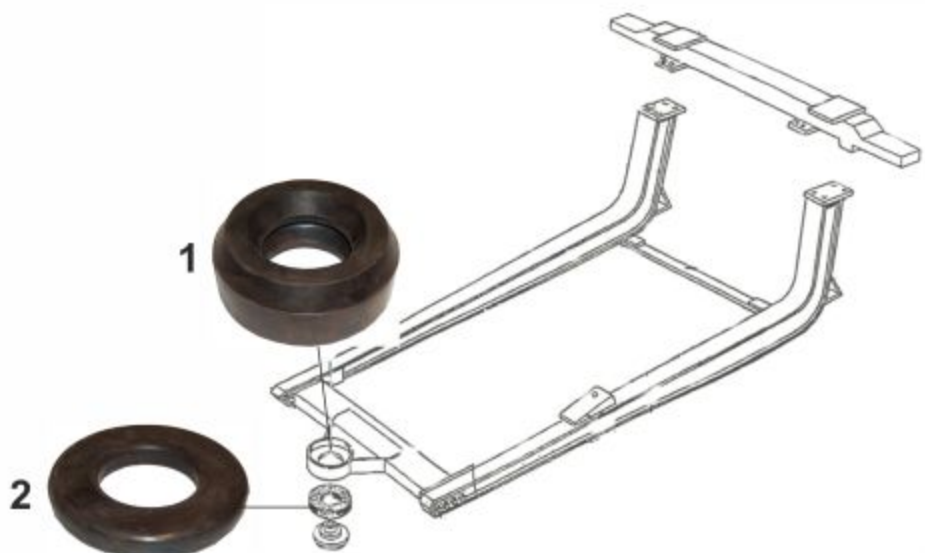

Fahrwerk Hinterachsfahrschemel / Subframe Suspension Neoplan

Version 2/ Neoplan ab Bj.2000/ Neoplan from year 2000

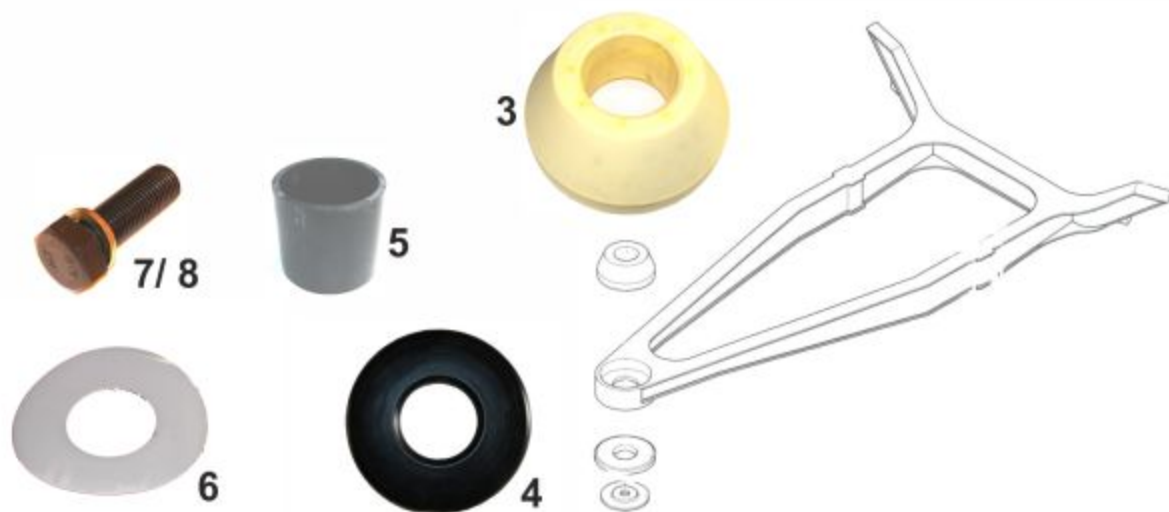

PL-number	pf./ applicable	Picture	OE/ OEM-Ref.	Dimension
015 441 008				
Fahrschemellager Subframe mounting	Neoplan ab Bj.2000	3	1101 444 0 36.96003.0001	DA=275/ DI=115/ H=30
015 441 007				
Fahrschemellager Subframe mounting	Neoplan ab Bj.2000	4	1101 444 4 36.43240.0002	DA=275/ DI=115/ H=125
015 441 006				
Hülse (mittig) Sleeve (center)	Neoplan ab Bj.2000	5	1101 443 8 36.96022.0000	115x7,5
015 441 012				
Schutzscheibe protective disc	Neoplan ab Bj.2000	6		DA=244 / DI=114 / H=2
015 441 014				
Schraube/ Screw	Neoplan ab Bj.2000	7		DIN933/ M36X110/ 10.9
015 441 015				
Sicherungsscheibe lock washer	Neoplan ab Bj.2000	8		Nordlock M36

Fahrwerk Hinterachsfahrschemel / Subframe Suspension Neoplan

Version 3/ ab Baujahr 09-2004

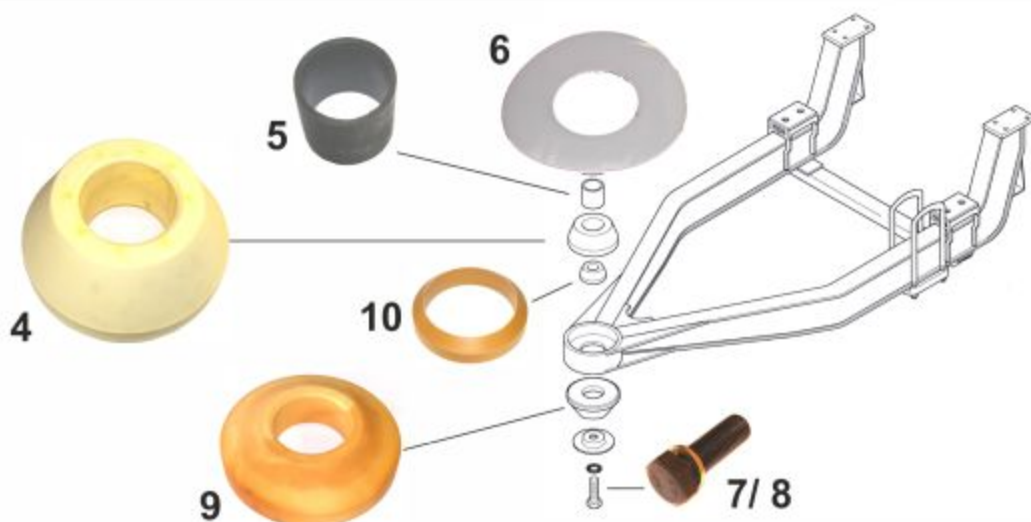

PL-number	pf./ applicable	Picture	OE/ OEM-Ref.	Dimension
015 441 020				
Fahrschemellager Subframe mounting	Neoplan	9	1111 798 0 36.43240.0006	DA=275/ DI=115/ H=60
015 441 018				
Führungsring guide ring	Neoplan	10	1111 842 8 36.96022.0001	DA=145/ DI=115/ H=35
015 441 007				
Fahrschemellager Subframe mounting	Neoplan	4	1101 444 4 36.43240.0002	DA=275/ DI=115/ H=125
015 441 006				
Hülse (mittig) Sleeve (center)	Neoplan	5	1101 443 8 36.96022.0000	115x7,5
015 441 012				
Schutzscheibe protective disc	Neoplan	6		DA=244 / DI=114 / H=2
015 441 014				
Schraube/ Screw	Neoplan	7		DIN933/ M36X110/ 10.9
015 441 015				
Sicherungsscheibe lock washer	Neoplan	8		Nordlock M36

PL-number	pf./ applicable for	OE/ OEM-Ref.	Dimension	picture
015 130 000				
Dreieckslenker Delta Guider	MB Bus 0350/ O404 oben/ top	356 333 13 04 613 333 01 04	L=507	

PL-number	pf./ applicable for	OE/ OEM-Ref.	Dimension	picture
015 130 001				
Dreieckslenker Delta Guider	MB Bus 0350/ O404 rechts unten/ right below	356 330 15 10	L=901	

PL-number	pf./ applicable for	OE/ OEM-Ref.	Dimension	picture
015 130 002				
Dreieckslenker Delta Guider	MB Bus 0350/ O404 links unten/ left below	356 330 14 10	L=901	

PL-number	pf./ applicable for	OE/ OEM-Ref.	Dimension	picture
015 131 000				
Reparatursatz Dreieckslenker repair Set Delta Guider	MB Bus O404 innen (2x)	000 350 10 05	67x115x15x24	

PL-number	pf./ applicable for	OE/ OEM-Ref.	Dimension	picture
015 131 001				
Reparatursatz Dreieckslenker repair Set Delta Guider	MB Bus O404 außen (1x)	000 350 11 05	DA=95 DA=44 H=72 M24x1,5	

PL-number	pf./ applicable for	OE/ OEM-Ref.	Dimension	picture
015 131 002				
Reparatursatz Dreieckslenker repair Set Delta Guider	MB Bus O404 innen (2x)	000 350 12 05	75x126x24x19	

PL-number	pf./ applicable for	OE/ OEM-Ref.	Dimension	picture
015 130 003				
Dreieckslenker Delta Guider	MB Truck Actros MP1-2	948 350 30 05 375 350 02 05 948 350 04 05 948 350 11 05	L=622	

PL-number	pf./ applicable for	OE/ OEM-Ref.	Dimension	picture
015 130 003.1				
Reparatursatz Repair-Set	MB Truck Actros MP1-2	000 350 45 05	75x130x24x25	

PL-number	pf./ applicable for	OE/ OEM-Ref.	Dimension	picture
015 130 003.2				
Reparatursatz Repair-Set	MB Truck Actros MP1-2	000 350 49 05	80x152x24x25	

PL-number	pf./ applicable for	OE/ OEM-Ref.	Dimension	picture
015 130 004				
Lenker Radaufhängung	MB Bus O350-530-580 Setra Serie/ mod.400	629 330 14 07 000 330 11 07 628 330 04 07	L=281	

PL-number	pf./ applicable for	OE/ OEM-Ref.	Dimension	picture
015 130 005				
Dreieckslenker Delta Guider	MB Truck Actros MP2-3 MB Truck Axor2	948 350 27 05	L=622/ B=503/ D=130	

PL-number	pf./ applicable for	OE/ OEM-Ref.	Dimension	picture
015 130 006				
Dreieckslenker Delta Guider	MB Truck Actros MP1-2 MB Truck Axor 1+2/ Atego MB Truck Econic	942 350 01 05 942 350 11 05 942 350 16 05	622x152/130x25/23	

PL-number	pf./ applicable for	OE/ OEM-Ref.	Dimension	picture
015 130 007				
Dreieckslenker Delta Guider	MB Truck Actros MP1-2-3-4 MB Truck Axor 1+2 MB Truck Antos/ Arocs MB Truck Econic2	942 350 05 05 942 350 08 05 942 350 12 05	622x152/130x25/23	

PL-number	pf./ applicable for	OE/ OEM-Ref.	Dimension	picture
015 331 032				
Reparaturset Repair-Set	015 130 006 (2x) 015 130 007 (2x)	000 350 20 05 000 350 47 05	67x130x23x24	

PL-number	pf./ applicable for	OE/ OEM-Ref.	Dimension	picture
015 152 026				
Reparaturset Repair-Set	015 130 006 (1x) 015 130 007 (1x)	000 350 21 05 000 350 46 05	75x152x25x24	

PL-number	pf./ applicable for	OE/ OEM-Ref.	Dimension	picture
015 130 008				
Dreieckslenker Delta Guider	MB Truck Actros MP1-2-3-4 MB Truck Axor2/ Atego MB Truck Antos/ Arocs MB Truck Econic	942 350 10 05 942 350 15 05 944 350 00 05 947 350 01 05 947 350 10 05	622x152/130x25/25	

PL-number	pf./ applicable for	OE/ OEM-Ref.	Dimension	picture
015 131 003				
Reparaturset Repair-Set	015 130 008 (1x)	000 350 44 05 000 350 23 05	85x125x25x24	

PL-number	pf./ applicable for	OE/ OEM-Ref.	Dimension	picture
015 130 003.1				
Reparaturset Repair-Set	015 130 008 (2x)	000 350 45 05	75x130x24x25	

PL-number	pf./ applicable for	OE/ OEM-Ref.	Dimension	picture
015 130 009				
Dreieckslenker Delta Guider	MB Truck Actros MP1-2-3-4 MB Truck Axor 1+2/ Atego MB Truck Arocs	944 350 03 05 944 350 05 05 947 350 09 05 948 350 04 05 948 350 30 05	622x152/130x25/25	

PL-number	pf./ applicable for	OE/ OEM-Ref.	Dimension	picture
015 152 003				
Reparatursatz Repair-Set	015 130 009	000 350 25 05	75x130x25x24	

PL-number	pf./ applicable for	OE/ OEM-Ref.	Dimension	picture
015 130 010				
Dreieckslenker Delta Guider	MB Truck Actros MP2-3 MB Truck Axor 2/ Zetros	948 350 28 05	667x152/130x25/23	

PL-number	pf./ applicable for	OE/ OEM-Ref.	Dimension	picture
015 152 024				
Reparatursatz Repair-Set	015 130 010 (2x)	000 350 37 05	85x130x23x30	

PL-number	pf./ applicable for	OE/ OEM-Ref.	Dimension	picture
015 152 023				
Reparatursatz Repair-Set	015 130 010 (1x)	000 350 36 05	98x82,3x152x108	

PL-number	pf./ applicable for	OE/ OEM-Ref.	Dimension	picture
015 130 011				
Dreieckslenker Delta Guider	MB Truck Actros 1+2 MB Truck Axor2	948 350 17 05 948 350 22 05	621,5x152/130/25/23	

PROFILINE

KLEEMANN SPARE PARTS

PL-number	pf./ applicable for	OE/ OEM-Ref.	Dimension	picture
015 190 002				
Dreieckslenker Delta Guider	MB Bus O500 Touro Bova Magiq Irizar Irisbus Domino Achse/ axle RL75E	000 350 07 06 20264198 42563373 42559868 42559868 42563373	L1=663/ L2=720 Konus=45	

PL-number	pf./ applicable for	OE/ OEM-Ref.	Dimension	picture
015 331 014				
Reparatursatz Repair-Set	015 190 002 (2x)	629 330 04 07 226127 42559870	DA=75/ DI=25 LA=130	

PL-number	pf./ applicable for	OE/ OEM-Ref.	Dimension	picture

PL-number	pf./ applicable for	OE/ OEM-Ref.	Dimension	picture

PL-number	pf./ applicable for	OE/ OEM-Ref.	Dimension	picture

PL-number	pf./ applicable for	OE/ OEM-Ref.	Dimension	picture

PL-number	pf./ applicable for	OE/ OEM-Ref.	Dimension	picture
015 252 015				
Reparatursatz Repair-Set	015 130 011 (2x)	000 350 28 05	85x130x25x24	

PL-number	pf./ applicable for	OE/ OEM-Ref.	Dimension	picture
015 152 007				
Reparatursatz Repair-Set	015 130 011 (1x)	000 350 29 05	108x152x25x24	

PL-number	pf./ applicable for	OE/ OEM-Ref.	Dimension	picture
015 240 003				
Dreieckslenker Delta Guider	MAN Truck F2000 TGA-TGS-TGX	81.43270.6116 81.43270.6137	627x509x152x48	

PL-number	pf./ applicable for	OE/ OEM-Ref.	Dimension	picture
015 241 004				
Reparatursatz Repair-Set	015 240 003 (1x)	81.43270.6110	100x152x25x24	

PL-number	pf./ applicable for	OE/ OEM-Ref.	Dimension	picture
015 252 015				
Reparatursatz Repair-Set	015 240 003 (2x)	81.43270.6105	85x130x25x24	

PL-number	pf./ applicable for	OE/ OEM-Ref.	Dimension	picture
015 240 004				
Dreieckslenker Delta Guider	MAN Truck F90/ E-F2000	81.43270.6057 81.43270.6030 81.43270.9034 81.43270.6078 81.43270.6034	627x152x58x23	

PL-number	pf./ applicable for	OE/ OEM-Ref.	Dimension	picture
015 241 002				
Reparaturatz Repair-Set	015 240 004 (1x)	81.95301.6132		

PL-number	pf./ applicable for	OE/ OEM-Ref.	Dimension	picture
015 240 005				
Dreieckslenker Delta Guider	MAN Truck TGA	81.43270.6096 81.43220.6221 81.43270.6114 81.43270.6121	627x130x48x23	

PL-number	pf./ applicable for	OE/ OEM-Ref.	Dimension	picture
015 152 027				
Reparaturatz Repair-Set	015 240 005 (2x)	81.43270.6126	85x130x23x24	

PL-number	pf./ applicable for	OE/ OEM-Ref.	Dimension	picture
015 241 002				
Reparaturatz Repair-Set	015 240 005 (1x)	81.95301.6132	90x80x61	

PL-number	pf./ applicable for	OE/ OEM-Ref.	Dimension	picture
015 240 006				
Dreieckslenker Delta Guider	MAN Truck TGA-TGS-TGX	81.43270.6097 81.43270.6113 81.43270.6135	627x152/130x25/23	

PL-number	pf./ applicable for	OE/ OEM-Ref.	Dimension	picture
015 240 007				
Dreieckslenker Delta Guider	MAN Truck M90/ F90/ M2000	81.43270.6053 81.43270.9053	693x115x50x19	

PL-number	pf./ applicable for	OE/ OEM-Ref.	Dimension	picture
015 241 003				
Reparatursatz Repair-Set	015 240 007 (1x)	81.43270.6065	72x46/ M20x1,5	

PL-number	pf./ applicable for	OE/ OEM-Ref.	Dimension	picture
015 331 015				
Reparatursatz Repair-Set	015 240 007 (2x)	81.43270.6091	75x115x19x24	

PL-number	pf./ applicable for	OE/ OEM-Ref.	Dimension	picture
015 240 008				
Dreieckslenker Delta Guider	MAN Truck F90/ F2000	81.43270.6056 81.43270.6075 81.43270.6077 81.43270.9056	627x152x58x23	

PL-number	pf./ applicable for	OE/ OEM-Ref.	Dimension	picture
015 241 006				
Reparatursatz Repair-Set	015 240 008 (2x)	81.43270.6079	95x152x24x23	

PL-number	pf./ applicable for	OE/ OEM-Ref.	Dimension	picture
015 241 002				
Reparatursatz Repair-Set	015 240 008 (1x) 240 009 (1x)	015 81.95301.6132	90x80x61	

PL-number	pf./ applicable for	OE/ OEM-Ref.	Dimension	picture
015 240 009				
Dreieckslenker Delta Guider	MAN Truck TGA-TGX	81.43270.6117	627x130x58x25	

PL-number	pf./ applicable for	OE/ OEM-Ref.	Dimension	picture
015 252 015				
Reparatursatz Repair-Set	015 240 009 (2x) 015 240 010 (2x)	81.43270.6105	85x130x25x24	

PL-number	pf./ applicable for	OE/ OEM-Ref.	Dimension	picture
015 240 010				
Dreieckslenker Delta Guider	MAN Truck E2000/ F2000 TGA-TGM-TGS-TGX	81.43270.6087 81.43270.6088 81.43270.6094 81.43270.6095	627x152/130x25	

PL-number	pf./ applicable for	OE/ OEM-Ref.	Dimension	picture
015 241 004				
Reparatursatz Repair-Set	015 240 010 (1x)	81.43270.6110	100x152x25x24	

PL-number	pf./ applicable for	OE/ OEM-Ref.	Dimension	picture

PL-number	pf./ applicable for	OE/ OEM-Ref.	Dimension	picture

PL-number	pf./ applicable for	OE/ OEM-Ref.	Dimension	picture

PL-number	pf./ applicable for	OE/ OEM-Ref.	Dimension	picture
015 330 000				
Dreieckslenker Delta Guider	MB Bus Travego Setra Serie/mod.400 VA unten front axle below	629 330 02 07 629 330 15 07	L=774/ B=720 Konus=45	

PL-number	pf./ applicable for	OE/ OEM-Ref.	Dimension	picture
015 331 013				
Reparatursatz Dreieckslenker unten Innenseite Repair Set	015 330 000 (1x)	629 330 01 07	L=172 D=85 Konus=45 M36x1,5	

PL-number	pf./ applicable for	OE/ OEM-Ref.	Dimension	picture
015 331 014				
Reparatursatz Dreieckslenker unten Außenseite Repair Set	015 330 000 (2x)	629 330 04 07 629 330 08 07 629 330 09 07	DA=75/ DI=25 LA=130	

PL-number	pf./ applicable for	OE/ OEM-Ref.	Dimension	picture
015 330 001				
Querlenker	MB Bus Travego Setra S411-415-417HD Setra 415-416-417 HDH Setra S431DT Setra S515-517HD axle ZF-RL-75/E	629 330 03 07	L=422/ B=600 B1=19/ B2=19	

PL-number	pf./ applicable for	OE/ OEM-Ref.	Dimension	picture
015 331 015				
Reparatursatz Dreieckslenker oben Innenseite Repair Set	015 330 001 (2x)	629 330 00 07	75x115x19x24	

PL-number	pf./ applicable for	OE/ OEM-Ref.	Dimension	picture

PL-number	pf./ applicable for	OE/ OEM-Ref.	Dimension	picture
015 340 000				
Dreieckslenker Hinterachs- fahrscemel Delta Guider	Setra Serie/mod. 200-300 HA/ rear axle	179.23.30.200.02		

PL-number	pf./ applicable for	OE/ OEM-Ref.	Dimension	picture
015 340 001				
Dreieckslenker Hinterachs- fahrscemel Delta Guider	Setra Serie 328DT HA/ rear axle	8.226.296.000 8.226.351.000 8.226.352.000	725x48x21	

PL-number	pf./ applicable for	OE/ OEM-Ref.	Dimension	picture
015 341 010				
Reparatursatz Repair-Set	015 340 001 (1x)	8.226.296.070	95x72x53,5	

PL-number	pf./ applicable for	OE/ OEM-Ref.	Dimension	picture

PL-number	pf./ applicable for	OE/ OEM-Ref.	Dimension	picture

PL-number	pf./ applicable for	OE/ OEM-Ref.	Dimension	picture

PL-number	pf./ applicable for	OE/ OEM-Ref.	Dimension	picture
015 440 000				
Dreieckslenker Delta Guider	Neoplan	N1.01101.4464	750x130x48x19	

PL-number	pf./ applicable for	OE/ OEM-Ref.	Dimension	picture
015 152 005				
Reparatursatz Repair-Set	015 440 000 (2x)	1101 354 7 0705 505 04	85x130x19x30	

PL-number	pf./ applicable for	OE/ OEM-Ref.	Dimension	picture
015 452 006				
Reparatursatz Repair-Set	015 440 000 (1x)	0827 509 05	72x46/ M20x1,5	

PL-number	pf./ applicable for	OE/ OEM-Ref.	Dimension	picture
015 452 001				
Reparatursatz Repair-Set	Neoplan Centroliner Hinterachse/ rear axle pf./ applicable for N1.01101-3443	0827 510 27	D=95/ H=72 M24x1,5	

PL-number	pf./ applicable for	OE/ OEM-Ref.	Dimension	picture

PL-number	pf./ applicable for	OE/ OEM-Ref.	Dimension	picture

PL-number	pf./ applicable for	OE/ OEM-Ref.	Dimension	picture
015 500 800				
Dreieckslenker Delta Guider	Volvo Truck FH12-16 / FL6/ FM9-12 NH12/ FH/ FM	20829503 Volvo 20392649 Volvo 1626896 Volvo 1076639 Volvo 1629734 Volvo	671x130x58x23	

PL-number	pf./ applicable for	OE/ OEM-Ref.	Dimension	picture
015 500 505				
Reparatursatz Repair-Set	015 500 800 (2x)	3093630 Volvo 20840815 Volvo	85x130x30x26x21	

PL-number	pf./ applicable for	OE/ OEM-Ref.	Dimension	picture
015 500 801				
Dreieckslenker Delta Guider	Volvo Truck 16/ FM7/ NH12	FH12- 20556490 Volvo 3173291 Volvo 8156991 Volvo	L=677x145x58x15	

PL-number	pf./ applicable for	OE/ OEM-Ref.	Dimension	picture
015 500 504				
Reparatursatz Repair-Set	015 500 801 (2x) 500 802 (2x)	015 1628107 Volvo	91x145/30x15	

PL-number	pf./ applicable for	OE/ OEM-Ref.	Dimension	picture
015 500 503				
Reparatursatz Repair-Set	015 500 801 (1x) 015 500 802 (1x)	20554908 Volvo	138,5x95/75/ M16x2	

PL-number	pf./ applicable for	OE/ OEM-Ref.	Dimension	picture
015 500 802				
Dreieckslenker Delta Guider	Volvo Truck FH12-16	3173293 Volvo 20556492 Volvo 1628135 Volvo	660x575x48x15	

PL-number	pf./ applicable for	OE/ OEM-Ref.	Dimension	picture
015 500 803				
Dreieckslenker Delta Guider	Volvo Truck C-Serie FE-FE2/ FH-FH2/ FH12-16 FH16-2/ FL6/ FM/ FMX FM7-9-10-12 Renault Truck Kerax Premium2	20741703 Volvo 20741695 Volvo 20556608 Volvo 20507262 Volvo 20367004 Volvo	662x115x50x19	

PL-number	pf./ applicable for	OE/ OEM-Ref.	Dimension	picture
015 500 506				
Reparatursatz Repair-Set	015 500 803	20741710 Volvo	D=72/ H=46	

PL-number	pf./ applicable for	OE/ OEM-Ref.	Dimension	picture
015 331 002				
Dreieckslenker Delta Guider	Volvo Bus B9S/ B10M/ B10B/ B12/ B12M/ B12CH VA-HA-NA/ axle Nr.1-2-3	27761 1194631	L=773/ B=48 B1=14/ B2=14	

PL-number	pf./ applicable for	OE/ OEM-Ref.	Dimension	picture
015 331 003				
Dreieckslenker Delta Guider	Volvo Truck FL6-12 HA/ rear axle	8073569 3172829	L=677/ B=48 B1=17/ B2=17	

PL-number	pf./ applicable for	OE/ OEM-Ref.	Dimension	picture
015 331 004				
Dreieckslenker Delta Guider	Volvo Truck FL6-12 HA/ rear axle	1094466 20382314 20502944	L=649/ B=627 D1=135/ D2=48	

PL-number	pf./ applicable for	OE/ OEM-Ref.	Dimension	picture
015 331 005				
Dreieckslenker Delta Guider				

PL-number	pf./ applicable for	OE/ OEM-Ref.	Dimension	picture
015 501 2000				
Dreieckslenker Delta Guider	Iveco Truck Stralis EuroStar/ EuroTech EuroTrakker/ Trakker	41034479 Iveco 41007770 Iveco 41042050 Iveco 41028600 Iveco	665x130x46x38	

PL-number	pf./ applicable for	OE/ OEM-Ref.	Dimension	picture
015 501 500				
Reparatursatz Repair-Set	015 501 2000 (2x)	93161960 Iveco	DA=75 DI=21 L=130	

PL-number	pf./ applicable for	OE/ OEM-Ref.	Dimension	picture
015 526 500				
Reparatursatz Repair-Set	015 501 2000 (1x) pf.NKW applicable for Truck	93161958 Iveco	72/65x46/ M20x1,5	

PL-number	pf./ applicable for	OE/ OEM-Ref.	Dimension	picture
015 501 502				
Reparatursatz Repair-Set	015 501 2000 (2x) Lochabstand=144	93161959 Iveco	L=144/ B=70/ D=38 M14x1,5	

PL-number	pf./ applicable for	OE/ OEM-Ref.	Dimension	picture

PL-number	pf./ applicable for	OE/ OEM-Ref.	Dimension	picture

PROFILINE

KLEEMANN SPARE PARTS

PL-number	pf./ applicable for	OE/ OEM-Ref.	Dimension	picture
015 526 900				
Dreieckslenker Delta Guider	Daf Truck LF55/ 95XF 65CF/ 75CF/ 85CF CF75/ CF85	1617096 Daf 1368270 Daf 1390932 Daf 1361651 Daf 1793875 Daf	609x152x50x23	

PL-number	pf./ applicable for	OE/ OEM-Ref.	Dimension	picture
015 252 013				
Reparaturatz Repair-Set	015 526 900	1376729 Daf	75x152x23x24	

PL-number	pf./ applicable for	OE/ OEM-Ref.	Dimension	picture

PL-number	pf./ applicable for	OE/ OEM-Ref.	Dimension	picture

PL-number	pf./ applicable for	OE/ OEM-Ref.	Dimension	picture

PL-number	pf./ applicable for	OE/ OEM-Ref.	Dimension	picture

Stoßdämpfer pf.MB Bus/ shock absorber applicable for MB Bus



PL-number	pf/ applicable for	Typ/ OE-ref.	Achse/ axle	end 1	end 2	brand
040 100 076	O530 LE	Euro5-6	HA/ rear axle	bold	bold	Sachs
040 100 079	O550-560-580	Euro6	NLA/ trailing axle	bold	bold	Sachs
040 100 080	O530 Citaro/ CapaCity L (elektrisch verstellbar)	Euro6	NLA/ trailing axle	bold	bold	Sachs
040 100 081	O345 Conecto/ O530 Citaro/ CapaCity L	Euro6	VA/ front axle	bold	bold	Sachs
040 100 082	O345 Conecto/ O530 Citaro/ CapaCity L	Euro6	HA/ rear axle	bold	bold	Sachs
040 100 083	O530 Citaro (LE und LowEntry)	Euro6	HA/ rear axle	bold	bold	Sachs
040 100 084	O530 Citaro K	Euro6	HA/ rear axle	bold	bold	Sachs
040 100 085	O530 Citaro K	Euro6	VA/ front axle	bold	bold	Sachs
040 100 086	Citaro (elektrisch verstellbar)	Euro6	HA/ rear axle	bold	bold	Sachs
040 100 087	Bus MB O530 Citaro (elektrisch verstellbar)	Euro6	VA/ front axle	bold	bold	Sachs
040 100 088	O345 Conecto/ O530 Citaro	Euro6	HA/ rear axle	bold	bold	Sachs
040 100 089	O345-350-530-580	Euro6	VA/ front axle	bold	bold	Sachs
040 100 091	O550 L Integro/ O580 Travego	Euro6	NLA/ trailing axle	bold	bold	Sachs
040 100 092	O550 L Integro	Euro6	HA/ rear axle	bold	bold	Sachs
040 100 093	O350 Turismo	Euro6	VA/ front axle	bold	bold	Sachs
040 100 094	O350 Turismo/ O580 Travego	Euro6	HA/ rear axle	bold	bold	Sachs
040 100 095	O350 Turismo/ O580 Travego	Euro6	VA/ front axle	bold	bold	Sachs
040 100 096PL	O309		VA/ front axle	eye	eye	Profiline
040 100 096PL	O309		HA/ rear axle	eye	eye	Profiline
040 100 101	O305-307-405-407-408	357 326 01 00	VA/ front axle	bold	bold	Sachs
040 100 101PL	O305-307-405-407-408	357 326 01 00	VA/ front axle	bold	bold	Profiline
040 100 101	O305-307-405-407-408	357 326 01 00	HA/ rear axle	bold	bold	Sachs
040 100 101PL	O305-307-405-407-408	357 326 01 00	HA/ rear axle	bold	bold	Profiline
040 101 102	O405N	005 323 54 00	VA/ front axle	eye	eye	Sachs
040 101 102K	O405N	005 323 54 00	VA/ front axle	eye	eye	Koni
040 100 102PL	O405N	005 323 54 00	VA/ front axle	eye	eye	Profiline
040 100 103	O405	357 320 03 31	HA/ rear axle	bold	bold	Sachs
040 100 103PL	O405	357 320 03 31	HA/ rear axle	bold	bold	Profiline
040 1000 104	O340/ O350/ O404	356 323 05 00	VA/ front axle	eye	eye	Sachs
040 100 104K	O340/ O350/ O404	356 323 05 00	VA/ front axle	eye	eye	Koni
040 100 104PL	O340/ O350/ O404	356 323 05 00	VA/ front axle	eye	eye	Profiline
040 100 105	O340/ O350/ O404	356 320 00 31	HA/ rear axle	bold	bold	Sachs
040 100 105K	O340/ O350/ O404	356 320 00 31	HA/ rear axle	bold	bold	Koni
040 100 105PL	O340/ O350/ O404	356 320 00 31	HA/ rear axle	bold	bold	Profiline
040 100 107	T2-LN1/ Vario	004 326 67 00	HA/ rear axle	eye	eye	Sachs
040 100 107PL	T2-LN1/ Vario	004 326 67 00	HA/ rear axle	eye	eye	Profiline
040 100 109	Vario	004 326 06 00	HA/ rear axle	eye	eye	Sachs
040 100 109PL	Vario	004 326 06 00	HA/ rear axle	eye	eye	Profiline
040 100 110	O530 Citaro	628 323 01 00	VA/ front axle	bold	bold	Sachs
040 100 110K	O530 Citaro	628 323 01 00	VA/ front axle	bold	bold	Koni
040 100 110PL	O530 Citaro	628 323 01 00	VA/ front axle	bold	bold	Profiline
040 100 111	O530 Citaro	628 326 07 00	HA/ rear axle	bold	bold	Sachs
040 100 111	O530 Citaro	628 326 07 00	HA/ rear axle	bold	bold	Koni
040 100 111	O530 Citaro	628 326 07 00	HA/ rear axle	bold	bold	Profiline
040 100 112	O530 Citaro	628 326 08 00	HA/ rear axle	bold	bold	Sachs
040 100 112PL	O530 Citaro	628 326 08 00	HA/ rear axle	bold	bold	Profiline
040 100 114	O550 Integro	8.231.371.000	VA/ front axle	eye	eye	Sachs
040 100 114K	O550 Integro	8.231.371.000	VA/ front axle	eye	eye	Koni
040 100 114PL	O550 Integro	8.231.371.000	VA/ front axle	eye	eye	Profiline
040 100 117	O580 Travego	629 323 00 00	VA/ front axle	eye	bold	Sachs
040 100 117K	O580 Travego	629 323 00 00	VA/ front axle	eye	bold	Koni
040 100 117PL	O580 Travego	629 323 00 00	VA/ front axle	eye	bold	Profiline
040 100 118	O580 Travego	629 326 01 00	HA/ rear axle	bold	bold	Sachs
040 100 118K	O580 Travego	629 326 01 00	HA/ rear axle	bold	bold	Koni
040 100 118PL	O580 Travego	629 326 01 00	HA/ rear axle	bold	bold	Profiline

Stoßdämpfer pf. Bus Neoplan

shock absorber applicable for bus Neoplan



PL-number	pf/ applicable for	axle	Achse/ axle	end 1	end 2	
040 100 202	N3516, N3516-3 Trendliner P23-P24-P25	L=640-460	HA/ rear axle	bold	bold	Sachs
040 100 202PL	N3516, N3516-3 Trendliner P23-P24-P25	L=640-460	HA/ rear axle	bold	bold	Profiline
040 100 207PL	Skyliner P05-P06, Starliner P11-P12	L=700-490	NLA/ trailing axle	bold	bold	Profiline
040 100 207PL	Tourliner P20-P21-P22, Cityliner P15-16	L=700-490	NLA/ trailing axle	bold	bold	Profiline
040 100 207PL	Tourliner P20-P21-P22, Trendliner P24-P25	L=700-490	VA/ front axle	bold	bold	Profiline
040 100 207PL	Starliner P11-P12	L=700-490	VA/ front axle	bold	bold	Profiline
040 100 302	N216	L=650-450	VA/ front axle	bold	bold	Sachs
040 100 302PL	N216	L=650-450	VA/ front axle	bold	bold	Koni
040 100 400	Überland sowie Reisebus	L=615-370	VA/ front axle	bold	bold	Sachs
040 100 400K	Überland sowie Reisebus	L=615-370	VA/ front axle	bold	bold	Koni
040 100 400PL	Überland sowie Reisebus	L=615-370	VA/ front axle	bold	bold	Profiline
040 100 400	Überland sowie Reisebus	L=615-370	HA/ rear axle	bold	bold	Sachs
040 100 400K	Überland sowie Reisebus	L=615-370	HA/ rear axle	bold	bold	Koni
040 100 400PL	Überland sowie Reisebus	L=615-370	HA/ rear axle	bold	bold	Profiline
040 100 400	Skyliner N1222 PB01-PB02, Euroliner	L=615-370	VA/ front axle	bold	bold	Sachs
040 100 400K	Skyliner N1222 PB01-PB02, Euroliner	L=615-370	VA/ front axle	bold	bold	Koni
040 100 400PL	Skyliner N1222 PB01-PB02, Euroliner	L=615-370	VA/ front axle	bold	bold	Profiline
040 100 400	Skyliner N1222 PB01-PB02, Euroliner	L=615-370	HA/ rear axle	bold	bold	Sachs
040 100 400K	Skyliner N1222 PB01-PB02, Euroliner	L=615-370	HA/ rear axle	bold	bold	Koni
040 100 400PL	Skyliner N1222 PB01-PB02, Euroliner	L=615-370	HA/ rear axle	bold	bold	Profiline
040 100 401	City Bus (axle VN8/ VN9NF-S)	L=630-460	VA/ front axle	bold	bold	Sachs
040 100 401PL	City Bus (axle VN8/ VN9NF-S)	L=630-460	VA/ front axle	bold	bold	Profiline
040 100 401.1	City Bus (axle AV132)	L=630-460	VA/ front axle	bold	bold	Sachs
040 100 401.1K	City Bus (axle AV132)	L=630-460	VA/ front axle	bold	bold	Koni
040 100 403	Doppeldecker sowie Dreiachser BM000	L=790-540	VA/ front axle	bold	bold	Sachs
040 100 403	Skyliner N1222 PB01-PB02	L=790-540	VA/ front axle	bold	bold	Sachs
040 100 403	Euroliner	L=790-540	NLA/ trailing axle	bold	bold	Sachs
040 100 403K	Doppeldecker sowie Dreiachser BM000	L=790-540	VA/ front axle	bold	bold	Koni
040 100 403K	Skyliner N1222 PB01-PB02	L=790-540	VA/ front axle	bold	bold	Koni
040 100 403K	Euroliner	L=790-540	NLA/ trailing axle	bold	bold	Koni
040 100 403PL	Doppeldecker sowie Dreiachser mit BM000	L=790-540	VA/ front axle	bold	bold	Profiline
040 100 403PL	Skyliner N1222 PB01-PB02	L=790-540	VA/ front axle	bold	bold	Profiline
040 100 403PL	Euroliner	L=790-540	NLA/ trailing axle	bold	bold	Profiline
040 100 404	N4013-N4016-N4021-N4022-N4032 (Starrachse)	L=630-460	VA/ front axle	bold	bold	Sachs
040 100 407	Starliner P11-P12, Cityliner P14-P15-P16	L=572-363	HA/ rear axle	bold	bold	Sachs
040 100 407	Tourliner P20-P21-P22, Trendliner P23-P24-P25	L=572-363	HA/ rear axle	bold	bold	Sachs
040 100 407	Jetliner P26-P27	L=572-363	HA/ rear axle	bold	bold	Sachs
040 100 407K	Starliner P11-P12, Cityliner P14-P15-P16	L=572-363	HA/ rear axle	bold	bold	Koni
040 100 407K	Tourliner P20-P21-P22, Trendliner P23-P24-P25	L=572-363	HA/ rear axle	bold	bold	Koni
040 100 407K	Jetliner P26-P27	L=572-363	HA/ rear axle	bold	bold	Koni
040 100 407PL	Starliner P11-P12, Cityliner P14-P15-P16	L=572-363	HA/ rear axle	bold	bold	Profiline
040 100 407PL	Tourliner P20-P21-P22, Trendliner P23-P24-P25	L=572-363	HA/ rear axle	bold	bold	Profiline
040 100 407PL	Jetliner P26-P27	L=572-363	HA/ rear axle	bold	bold	Profiline
040 100 409	Neoplan Centroliner N4013-N4014-N4032	L=680-530	HA/ rear axle	bold	bold	Sachs
040 100 410	N407	36x205	VA/ front axle	eye	eye	Sachs
040 100 410	N407	36x205	HA/ rear axle	eye	eye	Sachs
040 100 411	Skyliner P05-06, Starliner P11	elektrisch	VA/ front axle	bold	bold	OE
040 100 411	Cityliner P14-15-16	elektrisch	VA/ front axle	bold	bold	OE
040 100 412	Skyliner P05-06, Starliner P11-12	elektrisch	HA/ rear axle	bold	bold	Sachs
040 100 412	Cityliner P14-15-16	elektrisch	HA/ rear axle	bold	bold	Sachs
040 100 413	Skyliner P05, Starliner P11-P12	VA	VA/ front axle	bold	bold	OE
040 100 413	Cityliner P14-P15-P16	VA	VA/ front axle	bold	bold	OE
040 100 414	Skyliner P05-06, Starliner P11-12	HA	HA/ rear axle	bold	bold	OE
040 100 414	Cityliner P14-15-16	HA	HA/ rear axle	bold	bold	OE
040 100 415	Starliner P11-P12, Cityliner P14-P15-P16	VA	VA/ front axle	bold	bold	OE
040 100 415	Tourliner P21, Trendliner P23-P25	VA	VA/ front axle	bold	bold	OE

Stoßdämpfer pf. Bus Scania

shock absorber applicable for bus Scania



PL-number	pf/ applicable for	length	Achse/ axle	end 1	end 2	
040 100 651	Serie/ mod.3	L=662-408	VA/ front axle	bold	bold	Sachs
040 100 651PL	Serie/ mod.3	L=662-408	VA/ front axle	bold	bold	Profiline
040 100 652	Serie/ mod.3	L=599-353	HA/ rear axle	bold	bold	Sachs
040 100 652PL	Serie/ mod.3	L=599-353	HA/ rear axle	bold	bold	Profiline
040 100 653	Serie/ mod.3	L=810-477	NLA/ trailing axle	bold	eye	Sachs
040 100 653PL	Serie/ mod.3	L=810-477	NLA/ trailing axle	bold	eye	Profiline
040 100 670	Serie/ mod.4-F-K-N	L=542-341	HA/ rear axle	bold	bold	Sachs
040 100 670PL	Serie/ mod.4-F-K-N	L=542-341	HA/ rear axle	bold	bold	Profiline
040 100 671	Serie/ mod.4-F-K-N	L=653-395	VA/ front axle	bold	bold	Sachs
040 100 671PL	Serie/ mod.4-F-K-N	L=653-395	VA/ front axle	bold	bold	Profiline
040 100 672	Serie/ mod.3	L=610-369	HA/ rear axle	bold	bold	Sachs
040 100 672PL	Serie/ mod.3	L=610-369	HA/ rear axle	bold	bold	Profiline
040 100 673	Serie/ mod.4	L=674-454	VA/ front axle	eye	bold	Sachs
040 1000 673PL	Serie/ mod.4	L=674-454	VA/ front axle	eye	bold	Profiline
040 100 676K	Serie/ mod.4-F-K-N	L=662-422	HA/ rear axle	bold	bold	Sachs
040 100 676PL	Serie/ mod.4-F-K-N	L=662-422	HA/ rear axle	bold	bold	Profiline

Stoßdämpfer pf. Bus Irisbus-Renault

shock absorber applicable for bus Irisbus-Renault



PL-number	pf/ applicable for	length	Achse/ axle	end 1	end 2	
040 100 700PL	Ares/ FR1/ Iliade	L=491-317	VA/ front axle	bold	eye	Profiline
040 100 701	Ares/ FR1/ Iliade (außer GTE/GTXE)	L=726-435	HA/ rear axle	bold	eye	Sachs
040 100 701PL	Iliade (außer GTE/GTXE)	L=726-435	HA/ rear axle	bold	eye	Profiline
040 100 702PL	Iliade GTE/GTXE	L=709-432	HA/ rear axle	bold	eye	Profiline
040 100 705PL	PGC191-231/ PR10-12-14/ S-SL-SR	L=485-834	VA/ front axle	bold	bold	Profiline
040 100 705PL	PR10-12-15/ S-SL-SR	L=485-834	HA/ rear axle	bold	bold	Profiline
040 100 708	Agora	L=502-318	VA/ front axle	bold	bold	Sachs
040 100 708PL	Agora	L=502-318	VA/ front axle	bold	bold	Profiline
040 100 709	Agora	L=504-335	HA/ rear axle	bold	eye	Sachs
040 100 709PL	Agora	L=504-335	HA/ rear axle	bold	eye	Profiline
040 100 710	Agora	L=465-344	VA/ front axle	bold	bold	Sachs
040 100 710PL	Agora	L=465-344	VA/ front axle	bold	bold	Profiline

Stoßdämpfer pf. Bus Daf

shock absorber applicable for bus Daf



PL-number	pf/ applicable for	length	Achse/ axle	end 1	end 2	
040 100 850PL	SM200 Stadtbus	L=658-408		eye	eye	Profiline
040 100 850PL	SM200 Stadtbus	L=658-408	HA/ rear axle	eye	eye	Profiline
040 100 851PL	Daf Bus	L=629-428	HA/ rear axle	bold	bold	Profiline
040 100 852	SBR3000	L=791-463	VA/ front axle	bold	bold	Sachs
040 100 852PL	SBR3000	L=791-463	VA/ front axle	bold	bold	Profiline

Stoßdämpfer pf. Bus Temsa

shock absorber applicable for bus Temsa



PL-number	pf/ applicable for	OE-Ref.	length	end 1	end 2	
040 100 1700PL	Temsa Safir VA/ front axle	MC-371062	L=660-410	bold	eye	Profiline
040 100 1701PL	Temsa Safir HA/ rear axle	MC-371060	L=587-380	bold	eye	Profiline
040 100 1702PL	Temsa Metropol VA/ front axle	CM-114115Y	L=585-382	bold	eye	Profiline
040 100 1703PL	Temsa Metropol HA/ rear axle	CM-113106	L=475-302	bold	eye	Profiline

Stoßdämpfer pf.LKW MB

shock absorber applicable for Truck MB



PL-number	pf/ applicable for	Achse/ axle	OE-Ref.	length	end 1	end 2	
040 100 123	T2-LN2/ Vario	VA/ front axle	974 326 10 00	L=626-378	eye	eye	Sachs
040 100 123PL	T2-LN2/ Vario	VA/ front axle	974 326 10 00	L=626-378	eye	eye	Profiline
040 100 124	Atego 1-2	VA/ front axle	974 323 06 00	L=442-726	eye	eye	Sachs
040 100 124PL	Atego 1-2	VA/ front axle	974 323 06 00	L=442-726	eye	eye	Profiline
040 100 125	Atego 1-2	HA/ rear axle	974 326 01 00	L=742-453	eye	eye	Sachs
040 100 125PL	Atego 1-2	HA/ rear axle	974 326 01 00	L=742-453	eye	eye	Profiline
040 100 127	Actros MP1-2-3/ Axor 1-2/ Atego 1	VA/ front axle	005 323 97 00	L=855-515	eye	eye	Profiline
040 100 127PL	Actros MP1-2-3/ Axor 1-2/ Atego 1	VA/ front axle	005 323 97 00	L=855-515	eye	eye	Profiline
040 100 130	Atego1	VA/ front axle	972 323 01 00	L=658-408	eye	eye	Sachs
040 100 130PL	Atego1	VA/ front axle	972 323 01 00	L=658-408	eye	eye	Profiline
040 100 131	Truck MB NG-SK	HA/ rear axle	001 326 41 00	L=688-420	eye	eye	Sachs
040 100 131PL	Truck MB NG-SK	HA/ rear axle	001 326 41 00	L=688-420	eye	eye	Profiline
040 100 135	Atego 1-2	HA/ rear axle	970 326 01 00	L=700-425	eye	eye	Sachs
040 100 135PL	Atego 1-2	HA/ rear axle	970 326 01 00	L=700-425	eye	eye	Profiline
040 100 136	Truck MB NG-SK	HA/ rear axle	002 326 92 00	L=872-515	eye	eye	Sachs
040 100 136PL	Truck MB NG-SK	HA/ rear axle	002 326 92 00	L=872-515	eye	eye	Profiline
040 100 137	Unimog 1350L-1550L	HA/ rear axle	003 323 36 00	L=707-401	eye	eye	Sachs
040 100 137PL	Unimog 1350L-1550L	HA/ rear axle	003 323 36 00	L=707-401	eye	eye	Profiline
040 100 138	Unimog 1700-1750-1800-1850-2100-2150	VA/ front axle	003 323 70 00	L=755-473	eye	eye	Sachs
040 100 138PL	Unimog 1700-1750-1800-1850-2100-2150	VA/ front axle	003 323 70 00	L=755-473	eye	eye	Profiline
040 100 139	Truck MB NG	VA/ front axle	004 323 47 00	L=810-490	eye	eye	Sachs
040 100 139PL	Truck MB NG	VA/ front axle	004 323 47 00	L=810-490	eye	eye	Profiline
040 100 141	Truck MB MK-NG	VA/ front axle	004 323 33 00	L=912-535	eye	eye	Sachs
040 100 141PL	Truck MB MK-NG	VA/ front axle	004 323 33 00	L=912-535	eye	eye	Profiline
040 100 142	Truck MB SK	HA/ rear axle	004 326 64 00	L=750-454	eye	eye	Sachs
040 100 142PL	Truck MB SK	HA/ rear axle	004 326 64 00	L=750-454	eye	eye	Profiline
040 100 143	Truck MB MK	HA/ rear axle	004 326 70 00	L=712-435	eye	eye	Sachs
040 100 143PL	Truck MB MK	HA/ rear axle	004 326 70 00	L=712-435	eye	eye	Profiline
040 100 144	Truck MB LK-LN2, MK	HA/ rear axle	005 323 18 00	L=632-395	eye	eye	Sachs
040 100 144PL	Truck MB LK-LN2, MK	HA/ rear axle	005 323 18 00	L=632-395	eye	eye	Profiline
040 100 146	Truck MB LK-LN2, MK VA/ front axle	VA/ front axle	005 323 54 00	L=674-416	eye	eye	Sachs
040 100 146PL	Truck MB LK-LN2, MK VA/ front axle	VA/ front axle	005 323 54 00	L=674-416	eye	eye	Profiline
040 100 147	Actros MP1-2-3, Atego1, Axor2	HA/ rear axle	005 326 09 00	L=894-523	eye	eye	Sachs
040 100 147PL	Actros MP1-2-3, Atego1, Axor2	HA/ rear axle	005 326 09 00	L=894-523	eye	eye	Profiline
040 100 148	Actros MP1-2-3, Atego1, Axor2	HA/ rear axle	005 326 10 00	L=768-460	eye	eye	Sachs
040 100 148PL	Actros MP1-2-3, Atego1, Axor2	HA/ rear axle	005 326 10 00	L=768-460	eye	eye	Profiline
040 100 149	Actros MP1-2-3, Atego1, Axor2	HA/ rear axle	005 326 12 00	L=784-468	eye	eye	Sachs
040 100 149PL	Actros MP1-2-3, Atego1, Axor2	HA/ rear axle	005 326 12 00	L=784-468	eye	eye	Profiline
040 100 150	Actros MP1-2-3, Atego1, Axor2	HA/ rear axle	005 326 25 00	L=719-440	eye	eye	Sachs
040 100 150PL	Actros MP1-2-3, Atego1, Axor2	HA/ rear axle	005 326 25 00	L=719-440	eye	eye	Profiline
040 100 151	Truck MB LK-LN2	HA/ rear axle	005 326 29 00	L=722-440	eye	eye	Sachs
040 100 151PL	Truck MB LK-LN2	HA/ rear axle	005 326 29 00	L=722-440	eye	eye	Profiline
040 100 152	Truck MB LK-LN2 HA	HA/ rear axle	005 326 46 00	L=754-453	eye	eye	Sachs
040 100 152PL	Truck MB LK-LN2 HA	HA/ rear axle	005 326 46 00	L=754-453	eye	eye	Profiline
040 100 154	Truck MB LK-LN2	VA/ front axle	006 323 30 00	L=702-430	eye	eye	Sachs
040 100 154PL	Truck MB LK-LN2	VA/ front axle	006 323 30 00	L=702-430	eye	eye	Profiline
040 100 154	Truck MB LK-LN2	HA/ rear axle	006 323 30 00	L=702-430	eye	eye	Sachs
040 100 154PL	Truck MB LK-LN2	HA/ rear axle	006 323 30 00	L=702-430	eye	eye	Profiline
040 100 155	Truck MB LK-LN2	VA/ front axle	006 323 83 00	L=750-454	eye	eye	Sachs
040 100 155PL	Truck MB LK-LN2	VA/ front axle	006 323 83 00	L=750-454	eye	eye	Profiline
040 100 156	Actros MP1-2-3, Atego1, Axor2	HA/ rear axle	006 326 05 00	L=894-523	eye	eye	Sachs
040 100 156PL	Actros MP1-2-3, Atego1, Axor2	HA/ rear axle	006 326 05 00	L=894-523	eye	eye	Profiline
040 100 157	Actros MP2-3, Atego1, Axor2	HA/ rear axle	006 326 12 00	L=702-430	eye	eye	Sachs
040 100 157PL	Actros MP2-3, Atego1, Axor2	HA/ rear axle	006 326 12 00	L=702-430	eye	eye	Profiline
040 100 158	Truck MB NG	HA/ rear axle	381 326 02 00	L=758-452	bold	eye	Sachs
040 100 158PL	Truck MB NG	HA/ rear axle	381 326 02 00	L=758-452	bold	eye	Profiline

Stoßdämpfer pf.Transporter MB

shock absorber applicable for Light Truck MB



040 100 098PL	MB Sprinter (BM901-902-903-904)	VA/ front axle	903 320 05 30	L=560-377	bold	plate	Profiline
040 100 106	MB Sprinter Serie/mod. 200-300-400	VA/ front axle	690 320 71 30	L=660-355	bold	plate	Sachs
040 100 106PL	MB Sprinter Serie/mod. 200-300-400	VA/ front axle	690 320 71 30	L=660-355	bold	plate	Profiline
040 100 128	Sprinter Serie/mod.400 BM904 (Gas)	VA/ front axle	904 320 16 30	L=632-455	bold	plate	Sachs
040 100 128PL	Sprinter Serie/mod.400 BM904 (Gas)	VA/ front axle	904 320 16 30	L=632-455	bold	plate	Profiline
040 100 129	Sprinter Serie/mod.400 BM904 (Gas)	HA/ rear axle	904 320 02 31	L=516-324	eye	eye	Sachs
040 100 129PL	Sprinter Serie/mod.400 BM904 (Gas)	HA/ rear axle	904 320 02 31	L=516-324	eye	eye	Profiline
040 000 132	Sprinter BM901-902-903/ T1 BM601-602	HA/ rear axle	901 320 06 31	L=520-330	eye	eye	Sachs
040 100 132PL	Sprinter BM901-902-903/ T1 BM601-602	HA/ rear axle	901 320 06 31	L=520-330	eye	eye	Profiline
040 100 133	Sprinter Serie/mod.400 (BM904)	HA/ rear axle	904 320 02 31	L=522-348	eye	eye	Sachs
040 100 133PL	Sprinter Serie/mod.400 (BM904)	HA/ rear axle	904 320 02 31	L=522-348	eye	eye	Profiline
040 100 166	Sprinter 616CDI BM905 (Gas)	VA/ front axle	905 320 00 30	L=530-345	bold	plate	Sachs
040 100 166PL	Sprinter 616CDI BM905 (Gas)	VA/ front axle	905 320 00 30	L=530-345	bold	plate	Profiline
040 100 171	Sprinter BM901-902-903	HA/ rear axle	903 320 01 31	L=520-330	eye	eye	Sachs
040 100 171PL	Sprinter BM901-902-903	HA/ rear axle	903 320 01 31	L=520-330	eye	eye	Profiline
040 100 172	Sprinter BM906	VA/ front axle	906 320 76 30	L=438-259	bold	plate	Sachs
040 100 172PL	Sprinter BM906	VA/ front axle	906 320 76 30	L=438-259	bold	plate	Profiline
040 100 173	Sprinter BM906	HA/ rear axle	906 326 13 00	L=517-332	eye	eye	Sachs
040 100 173PL	Sprinter BM906	HA/ rear axle	906 326 13 00	L=517-332	eye	eye	Profiline
040 100 177	MB T1 VA/ front axle	VA/ front axle	601 320 07 30	L=595-358	eye	eye	Sachs
040 100 177PL	MB T1 VA/ front axle	VA/ front axle	601 320 07 30	L=595-358	eye	eye	Profiline
040 100 178	Sprinter BM 901-902-903	HA/ rear axle	602 320 08 31	L=511-321	eye	eye	Sachs
040 100 178PL	Sprinter BM 901-902-903	HA/ rear axle	602 320 08 31	L=511-321	eye	eye	Profiline
040 100 179	MB T1-TN	VA/ front axle	611 320 09 30	L=600-368	eye	eye	Sachs
040 100 179PL	MB T1-TN	VA/ front axle	611 320 09 30	L=600-368	eye	eye	Profiline
040 100 180	MB T1-TN	HA/ rear axle	611 320 07 31	L=545-343	eye	eye	Sachs
040 100 180PL	MB T1-TN	HA/ rear axle	611 320 07 31	L=545-343	eye	eye	Profiline
040 100 182	MB Vito, V-Class (BM638/ 638-2)	HA/ rear axle	638 326 12 00	L=497-362	eye	eye	Sachs
040 100 182PL	MB Vito, V-Class (BM638/ 638-2)	HA/ rear axle	638 326 12 00	L=497-362	eye	eye	Profiline
040 100 183	MB 100 (BM631)	VA/ front axle	631 320 16 30	L=453-302	eye	eye	Sachs
040 100 183PL	MB 100 (BM631)	VA/ front axle	631 320 16 30	L=453-302	eye	eye	Profiline
040 100 184	MB T1 (BM602)	HA/ rear axle	602 320 12 31	L=520-330	eye	eye	Sachs
040 100 184PL	MB T1 (BM602)	HA/ rear axle	602 320 12 31	L=520-330	eye	eye	Profiline
040 100 193	MB Vito, V-Class (BM638/ 638-2)	VA/ front axle	638 320 10 13	L=576-420	bolb	plate	Sachs
040 100 193PL	MB Vito, V-Class (BM638/ 638-2)	VA/ front axle	638 320 10 13	L=576-420	bold	plate	Profiline

Stoßdämpfer pf.Transporter VW

shock absorber applicable for Light Truck VW



040 100 128	LT28-46 II VA/ front axle (Gas)	VA/ front axle	904 320 16 30	L=632-455	bold	plate	Sachs
040 100 128PL	LT28-46 II VA/ front axle (Gas)	VA/ front axle	904 320 16 30	L=632-455	bold	plate	Profiline
040 100 129	LT28-46 II HA/ rear axle (Gas)	HA/ rear axle	904 320 02 31	L=516-324	eye	eye	Sachs
040 100 129PL	LT28-46 II HA/ rear axle (Gas)	HA/ rear axle	904 320 02 31	L=516-324	eye	eye	Profiline
040 100 133	LT 28-46 II HA/ rear axle	HA/ rear axle	904 320 02 31	L=522-348	eye	eye	Sachs
040 100 133PL	LT 28-46 II HA/ rear axle	HA/ rear axle	904 320 02 31	L=522-348	eye	eye	Profiline
040 100 133	LT28-46 II HA/ rear axle	HA/ rear axle	904 320 02 31	L=522-348	eye	eye	Sachs
040 100 133PL	LT28-46 II HA/ rear axle	HA/ rear axle	904 320 02 31	L=522-348	eye	eye	Profiline
040 100 172	Crafter 30-35-50	VA/ front axle	906 320 76 30	L=438-259	bold	plate	Sachs
040 100 172PL	Crafter 30-35-50	VA/ front axle	906 320 76 30	L=438-259	bold	plate	Profiline
040 100 173	Crafter 30-35-50	HA/ rear axle	906 326 13 00	L=517-332	eye	eye	Sachs
040 100 173PL	Crafter 30-35-50	HA/ rear axle	906 326 13 00	L=517-332	eye	eye	Profiline
040 100 178	LT28-46 II/ LT28-35 II	HA/ rear axle	602 320 08 31	L=511-321	eye	eye	Sachs
040 100 178PL	LT28-46 II/ LT28-35 II	HA/ rear axle	602 320 08 31	L=511-321	eye	eye	Profiline

Stoßdämpfer pf.LKW MAN

shock absorber applicable for Truck MAN

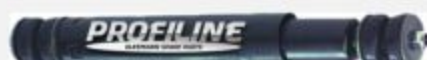

PL-number	pf/ applicable for		OE-Ref.	length	end 1	end 2	
040 100 208	G90, F2000	VA/ front axle	81.43701.6354	L=598-358	bold	bold	Sachs
040 100 208PL	G90, F2000	VA/ front axle	81.43701.6354	L=598-358	bold	bold	Profiline
040 100 209	TGA	VA/ front axle	81.43701.6900	L=669-403	bold	bold	Sachs
040 100 209PL	TGA	VA/ front axle	81.43701.6900	L=669-403	bold	bold	Profiline
040 100 210	M90, F90	VA/ front axle	81.43701.6794	L=685-420	bold	eye	Sachs
040 100 210PL	M90, F90	VA/ front axle	81.43701.6794	L=685-420	bold	eye	Profiline
040 100 211	F90, TGA	VA/ front axle	81.43701.6426	L=712-435	eye	eye	Sachs
040 100 211PL	F90, TGA	VA/ front axle	81.43701.6426	L=712-435	eye	eye	Profiline
040 100 212	M90	HA/ rear axle	81.43701.6680	L=669-426	eye	eye	Sachs
040 100 212PL	M90	HA/ rear axle	81.43701.6680	L=669-426	eye	eye	Profiline
040 100 213	TGA-TGS-TGX	HA/ rear axle	81.43701.6950	L=580-373	eye	eye	Sachs
040 100 213PL	TGA-TGS-TGX	HA/ rear axle	81.43701.6950	L=580-373	eye	eye	Profiline
040 100 215	MAN-Büssing	VA/ front axle	81.43701.6178	L=788-475	eye	bold	Sachs
040 100 215PL	MAN-Büssing	VA/ front axle	81.43701.6178	L=788-475	eye	bold	Profiline
040 100 217	F90, F2000	HA/ rear axle	81.43701.6584	L=671-426	eye	eye	Sachs
040 100 217PL	F90, F2000	HA/ rear axle	81.43701.6584	L=671-426	eye	eye	Profiline
040 100 218	F90, F2000	HA/ rear axle	81.43701.6594	L=704-425	bold	eye	Sachs
040 100 218PL	F90, F2000	HA/ rear axle	81.43701.6594	L=704-425	bold	eye	Profiline
040 100 219	F90, M90, TGA	HA/ rear axle	81.43701.6568	L=768-460	eye	eye	Sachs
040 100 219PL	F90, M90, TGA	HA/ rear axle	81.43701.6568	L=768-460	eye	eye	Profiline
040 100 220	F90, M90, F2000, M2000	VA/ front axle	81.43701.6612	L=772-463	bold	bold	Sachs
040 100 220PL	F90, M90, F2000, M2000	VA/ front axle	81.43701.6612	L=772-463	bold	bold	Profiline
040 100 221PL	F90	VA/ front axle	81.43701.6619	L=735-440	bold	bold	Profiline
040 100 223	L2000	HA/ rear axle	81.43701.6782	L=658-408	eye	eye	Sachs
040 100 223PL	L2000	HA/ rear axle	81.43701.6782	L=658-408	eye	eye	Profiline
040 100 224	TGA	HA/ rear axle	81.43701.6902	L=771-404	bold	eye	Sachs
040 100 224PL	TGA	HA/ rear axle	81.43701.6902	L=771-404	bold	eye	Profiline
040 100 225PL	TGA	VA/ front axle	81.43701.6903	L=445-736	bold	bold	Profiline
040 100 226PL	TGA-TGS	HA/ rear axle	81.43701.6974	L=410-677	bold	bold	Profiline
040 100 227	M2000	VA/ front axle	81.43701.6841	L=742-450	eye	eye	Sachs
040 100 227PL	M2000	VA/ front axle	81.43701.6841	L=742-450	eye	eye	Profiline
040 100 288	TGA-TGS	HA/ rear axle	81.43701.6908	L=778-472	eye	eye	Sachs
040 100 228PL	TGA-TGS	HA/ rear axle	81.43701.6908	L=778-472	eye	eye	Profiline
040 100 229	TGA-TGS	HA/ rear axle	81.43701.6912	L=901-532	eye	eye	Sachs
040 100 229PL	TGA-TGS	HA/ rear axle	81.43701.6912	L=901-532	eye	eye	Profiline
040 100 230	TGA-TGS	VA/ front axle	81.43701.6991	L=864-505	eye	eye	Sachs
040 100 230PL	TGA-TGS	VA/ front axle	81.43701.6991	L=864-505	eye	eye	Profiline
040 100 232	TGA-TGS-TGX	VA/ front axle	81.43702.6078	L=870-545	eye	eye	Sachs
040 100 232PL	TGA-TGS-TGX	VA/ front axle	81.43702.6078	L=870-545	eye	eye	Profiline
040 100 233	TGA-TGS-TGX	HA/ rear axle	81.43701.6934	L=735-455	eye	eye	Sachs
040 100 233PL	TGA-TGS-TGX	HA/ rear axle	81.43701.6934	L=735-455	eye	eye	Profiline
040 100 234	F2000	VA/ front axle	81.43701.6888	L=705-440	bold	eye	Sachs
040 100 234PL	F2000	VA/ front axle	81.43701.6888	L=705-440	bold	eye	Profiline
040 100 235	TGA-TGS-TGX	HA/ rear axle	81.43702.6100	L=680-428	eye	eye	Sachs
040 100 235PL	TGA-TGS-TGX	HA/ rear axle	81.43702.6100	L=680-428	eye	eye	Profiline
040 100 236	TGA-TGS-TGX	HA/ rear axle	81.43701.6798	L=595-373	eye	eye	Sachs
040 100 236PL	TGA-TGS-TGX	HA/ rear axle	81.43701.6798	L=595-373	eye	eye	Profiline
040 100 237	L2000, M2000	VA/ front axle	81.43701.6789	L=617-357	bold	bold	Sachs
040 100 237PL	L2000, M2000	VA/ front axle	81.43701.6789	L=617-357	bold	bold	Profiline
040 100 238	M90	VA/ front axle	81.43701.6651	L=670-410	bold	bold	Sachs
040 100 238PL	M90	VA/ front axle	81.43701.6651	L=670-410	bold	bold	Profiline
040 100 264	M90	HA/ rear axle	81.43701.6658	L=650-415	eye	plate	Sachs
040 100 264PL	M90	HA/ rear axle	81.43701.6658	L=650-415	eye	plate	Profiline
040 100 265	F2000, L2000, M2000	VA/ front axle	81.43701.6804	L=630-377	bold	eye	Sachs
040 100 265PL	F2000, L2000, M2000	VA/ front axle	81.43701.6804	L=630-377	bold	eye	Profiline
040 100 266	M90	VA/ front axle	81.43701.6641	L=640-373	bold	bold	Sachs

Stoßdämpfer pf.LKW Scania shock absorber applicable for Truck Scania



PL-number	pf/ applicable for		OE-Ref.	length	end 1	end 2	
040 100 655	Serie/ mod.4, P-G-R-T	VA/ front axle	0307111	L=727-435	bold	eye	Sachs
040 100 655PL	Serie/ mod.4, P-G-R-T	VA/ front axle	0307111	L=727-435	bold	eye	Profiline
040 100 658	Serie/ mod.3	VA/ front axle	1314479	L=725-440	bold	bold	Sachs
040 100 658PL	Serie/ mod.3	VA/ front axle	1314479	L=440-725	bold	bold	Profiline
040 100 659	Serie/ mod.3	VA/ front axle	1327145	L=825-484	bold	eye	Sachs
040 100 659PL	Serie/ mod.3	VA/ front axle	1327145	L=825-484	bold	eye	Profiline
040 100 659	Serie/ mod.3-4	HA/ rear axle	1327813	L=825-484	bold	eye	Sachs
040 100 659PL	Serie/ mod.3-4	HA/ rear axle	1327813	L=825-484	bold	eye	Profiline
040 100 660	Serie/ mod.3	NLA/ trailing axle	1331755	L=595-375	bold	eye	Profiline
040 100 660PL	Serie/ mod.3	NLA/ trailing axle	1331755	L=595-375	bold	eye	Profiline
040 100 661	Serie/ mod.3	NLA/ trailing axle	1340264	L=665-410	bold	eye	Sachs
040 100 661PL	Serie/ mod.3	NLA/ trailing axle	1340264	L=665-410	bold	eye	Profiline
040 100 662	Serie/ mod.3	VA/ front axle	0272400	L=866-505	bold	eye	Sachs
040 100 662PL	Serie/ mod.3	VA/ front axle	0272400	L=866-505	bold	eye	Profiline
040 100 662	Serie/ mod.3, 4, P-G-R-T	HA/ rear axle	1353105	L=866-505	bold	eye	Sachs
040 100 662PL	Serie/ mod.3, 4, P-G-R-T	HA/ rear axle	1353105	L=866-505	bold	eye	Profiline
040 100 663	Serie/ mod.3	VA/ front axle	1354966	L=778-462	bold	eye	Sachs
040 100 663PL	Serie/ mod.3	VA/ front axle	1354966	L=778-462	bold	eye	Profiline
040 100 663	Serie/ mod.3	HA/ rear axle	1334250	L=778-462	bold	eye	Sachs
040 100 663PL	Serie/ mod.3	HA/ rear axle	1334250	L=778-462	bold	eye	Profiline
040 100 664	Serie/ mod.4, P-G-R-T	VA/ front axle	1478501	L=778-462	bold	eye	Sachs
040 100 664PL	Serie/ mod.4, P-G-R-T	VA/ front axle	1478501	L=778-462	bold	eye	Profiline
040 100 664	Serie/ mod.3	NLA/ trailing axle	1377058	L=778-462	bold	eye	Sachs
040 100 664PL	Serie/ mod.3	NLA/ trailing axle	1377058	L=778-462	bold	eye	Profiline
040 100 665	Serie/ mod, 4, P-G-R-T	HA/ rear axle	1519629	L=996-520	bold	bold	Sachs
040 100 665PL	Serie/ mod, 4, P-G-R-T	HA/ rear axle	1519629	L=996-520	bold	bold	Profiline
040 100 666	Serie/ mod.4, P-G-R-T	HA/ rear axle	1397523	L=964-558	eye	eye	Sachs
040 100 666PL	Serie/ mod.4, P-G-R-T	HA/ rear axle	1397523	L=964-558	eye	eye	Profiline
040 100 667	Serie/ mod, 4, P-G-R-T	VA/ front axle	1478500	L=896-520	bold	eye	Profiline
040 100 667PL	Serie/ mod, 4, P-G-R-T	VA/ front axle	1478500	L=896-520	bold	eye	Profiline
040 100 668	Serie/ mod.3	HA/ rear axle	1478502	L=864-505	bold	eye	Sachs
040 100 668PL	Serie/ mod.3	HA/ rear axle	1478502	L=864-505	bold	eye	Profiline
040 100 669	Serie/ mod, 4, P-G-R-T	NLA/ trailing axle	1478511	L=587-365	bold	eye	Sachs
040 100 669PL	Serie/ mod, 4, P-G-R-T	NLA/ trailing axle	1478511	L=587-365	bold	eye	Profiline
040 100 674	Serie/ mod.4, P-G-R-T	HA/ rear axle	2031227	L=803-475	eye	eye	Sachs
040 100 674PL	Serie/ mod.4, P-G-R-T	HA/ rear axle	2031227	L=803-475	eye	eye	Profiline
040 100 675	Serie/ mod, 4, P-G-R-T	HA/ rear axle	1510630	L=869-521	eye	eye	Sachs
040 100 675PL	Serie/ mod, 4, P-G-R-T	HA/ rear axle	1510630	L=869-521	eye	eye	Profiline
040 100 675	Serie/ mod, 4, P-G-R-T	NLA/ trailing axle	1510630	L=869-521	eye	eye	Sachs
040 100 675PL	Serie/ mod, 4, P-G-R-T	NLA/ trailing axle	1510630	L=869-521	eye	eye	Profiline

Stoßdämpfer pf.Achsen BPW

shock absorber applicable for axle BPW



PL-number	pf/ applicable for	OE-Ref.	length	end 1	end 2	
040 100 1000PL	BPW	02.3702.67.00	L=764-471	eye	eye	Profiline
040 100 1001PL	BPW	02.3702.20.00	L=696-444	eye	eye	Profiline
040 100 1002PL	BPW	02.3702.18.00	L=769-494	eye	eye	Profiline
040 100 1003PL	BPW	02.3722.83.00	L=495-325	eye	eye	Profiline
040 100 1004PL	BPW	02.3702.92.00	L=540-350	eye	eye	Profiline
040 100 1005PL	BPW	02.3702.70.00	L=432-292	eye	eye	Profiline
040 100 1006PL	BPW	02.3702.51.00	L=700-430	eye	eye	Profiline

Stoßdämpfer pf.Achsen SAF

shock absorber applicable for axle SAF



PL-number	pf/ applicable for	OE-Ref.	length	end 1	end 2	
040 100 1000PL	SAF	02.3702.67.00	L=764-471	eye	eye	Profiline
040 100 1003PL	SAF	02.3722.83.00	L=495-325	eye	eye	Profiline
040 100 1004PL	SAF	02.3702.92.00	L=540-350	eye	eye	Profiline
040 100 1005PL	SAF	02.3702.70.00	L=432-292	eye	eye	Profiline
040 100 1008PL	SAF	2.376.0020.00	L=560-360	eye	eye	Profiline
040 100 1010PL	SAF	2.376.0073.01	L=460-300	eye	eye	Profiline
040 100 1011PL	SAF	2.376.0030.00	L=475-315	eye	eye	Profiline
040 100 1100PL	SAF	2.376.0010.02	L=475-315	eye	eye	Profiline
040 100 1101PL	SAF	2.376.0072.01	L=532-335	eye	eye	Profiline
040 100 1102PL	SAF	2.376.0010.00	L=475-315	eye	eye	Profiline
040 100 1103PL	SAF	2.376.0003.02	L=617-372	eye	eye	Profiline
040 100 1104PL	SAF	2.376.0002.00	L=635-385	eye	eye	Profiline
040 100 1105PL	SAF	02.3702.83.00	L=661-411	eye	eye	Profiline
040 100 1107PL	SAF	02.3702.14.00	L=674-416	eye	eye	Profiline
040 100 1108PL	SAF	2.376.0009.00	L=512-332	eye	eye	Profiline
040 100 1109PL	SAF	2.376.0070.00	L=413-278	eye	eye	Profiline
040 100 1110PL	SAF	2.376.0071.00	L=491-315	eye	eye	Profiline

Stoßdämpfer pf.Achsen Trailor

shock absorber applicable for axle Trailor



PL-number	pf/ applicable for	OE-Ref.	length	end 1	end 2	
040 100 1003PL	Trailor	02.3722.83.00	L=495-325	eye	eye	Profiline
040 100 1200PL	Trailor	6505245	L=528-340	eye	eye	Profiline

Stoßdämpfer pf.Achsen Gigant

shock absorber applicable for axle Gigant

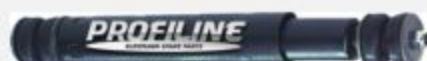



PL-number	pf/ applicable for	OE-Ref.	length	end 1	end 2	
040 100 1300PL	Gigant	196111	L=502-331	eye	eye	Profiline

PL-number	pf./ applicable for	OE-Ref.	Dimension	picture
045 000 000				
Rollbalgträger Piston black/ steel powder-coated	661N Neoplan diverse	36.43603.0005 1101 637 5	DA=235 DI=150 H=180	

PL-number	pf./ applicable for	OE-Ref.	Dimension	picture
045 000 000.1				
obere Platte upper plate black/ steel powder-coated	661N Neoplan diverse MAN Bus 292-332-362/ A69	1101 633 0	DA=300 DI=150 H1=5 H2=25 Bohrung M10	

PL-number	pf./ applicable for	OE-Ref.	Dimension	picture
045 000 001				
Rollbalgträger Piston black/ steel powder-coated	662N Neoplan diverse	36.43603.0004 N1.01101.6369	DA=300 DI=150 H1=5 H2=25 Bohrung M10	

PL-number	pf./ applicable for	OE-Ref.	Dimension	picture
045 000 001.1				
obere Platte upper plate black/ steel powder-coated	662N Neoplan	36.43640.2000	DA=350 DI=195 H1=0,7 H2=30 Bohrung M10	

PL-number	pf./ applicable for	OE-Ref.	Dimension	picture
045 000 002				
Rollbalgträger Piston black/ steel powder-coated	644N MB Bus Setra 400 Serie	357 320 01 34 357 320 15 34	DA=250 DI=125 H=110	

PL-number	pf./ applicable for	OE-Ref.	Dimension	picture
045 000 003				
Rollbalgträger Piston black aluminium powder-coated	882N-883N-1885N MAN Bus ND LionsCity DD	81.43603.0041	H=130 B=170	

PL-number	pf./ applicable for	OE-Ref.	Dimension	picture
045 000 004				
Rollbalgräger Piston black/ steel powder-coated	720N 4713N Volvo	8471473 9158105	H=170 B=190	

PL-number	pf./ applicable for	OE-Ref.	Dimension	picture
045 000 004.1				
Rollbalgräger Piston black/ steel powder-coated	720N 4713N Volvo	3950209 1599310 3950209 8157021	H=172 B=190	

PL-number	pf./ applicable for	OE-Ref.	Dimension	picture
045 000 005				
Rollbalgräger Piston black/ steel powder-coated	713N 716N Volvo		H=177 B=235	

PL-number	pf./ applicable for	OE-Ref.	Dimension	picture
045 000 006				
Rollbalgräger Piston black/ aluminium powder-coated	Volvo	20475270 31184410	H=120 B=170	

	pf./ applicable for	OE-Ref.	Dimension	picture
045 000 008				
Rollbalgräger Piston black/ steel powder-coated	MB Bus O350-404 left side	356 320 22 43	DA=250 DI=145 H=210	

PL-number	pf./ applicable for	OE-Ref.	Dimension	picture
045 000 009				
Rollbalgräger Piston black/ steel powder-coated	MB Bus O350-404 right side	356 320 23 43	DA=250 DI=145 H=210	

PL-number	pf./ applicable for	OE-Ref.	Dimension	picture
045 000 009.1				
obere Platte upper plate	O350-403-404 mit Conti RZ450-25	618 320 00 35	285x145 H1=0,4 H2=30	

PL-number	pf./ applicable for	OE-Ref.	Dimension	picture
045 000 010				
Rollbalgträger Piston steel	MB Truck Actros	941 320 04 18	DA=195 DI=132 H=150	

PL-number	pf./ applicable for	OE-Ref.	Dimension	picture
045 000 011				
Rollbalgträger Piston black/ steel powder-coated	MB Truck mit Conti 673N	393 320 10 18	D1=130,8 D2=210 H=150	

PL-number	pf./ applicable for	OE-Ref.	Dimension	picture
045 000 012				
Rollbalgträger Piston black/ steel powder-coated	Setra VA mit Conti 661N	107.23.10.101.04	DA=225 DI=150 H=140 M14x1,5	

PL-number	pf./ applicable for	OE-Ref.	Dimension	picture
045 000 012.1				
obere Platte upper plate	Setra VA mit Conti 661N	107.23.10.102.04	DA=375x315 DI=150 LA=340 zu 60 H1=0,5 H2=30	

PL-number	pf./ applicable for	OE-Ref.	Dimension	picture
045 000 012.1A				
obere Platte upper plate	Setra VA mit Conti 661N	107.23.10.102.03	DA=375x315 DI=150 LA=340 zu 60 H1=0,5 H2=30	

PL-number	pf./ applicable for	OE-Ref.	Dimension	picture
045 000 013				
Rollbalgräger Piston black/ steel powder-coated	MB Bus O580 Setra HA mit Conti 644N S415-416-417HDH S431DT	107.23.10.103.03 629 320 00 18 667 328 00 01 000 327 00 18	DA=195 DI=130 H=125	

PL-number	pf./ applicable for	OE-Ref.	picture
045 000 013.1			
obere Platte upper plate	Setra HA mit Conti 644N	107.23.36.102.11	

PL-number	pf./ applicable for	OE-Ref.	Dimension	picture
045 000 014				
Rollbalgräger Piston black/ steel powder-coated	Bova mit Conti 701N Taurus B116		DA=220 DI=220 H=130	

PL-number	pf./ applicable for	OE-Ref.	Dimension	picture
045 000 014.1				
obere Platte upper plate	Bova mit Conti 701N Taurus B116		L=390 B=300 DI=178 H1=0.4 H2=22 L zu L=355	

PL-number	pf./ applicable for	OE-Ref.	Dimension	picture
045 000 017				
Rollbalgräger Piston black/ steel powder-coated	BPW mit Conti 941MB	03.139.39.42.0	D=201 H=188	

PL-number	pf./ applicable for	OE-Ref.	Dimension	picture
045 000 018				
Rollbalgräger Piston black/ steel powder-coated	BPW mit Conti 881MB	03.139.39.43.0	D=251 H=188	

PL-number	pf./ applicable for	OE-Ref.	Dimension	picture
045 000 019				
Rollbalgträger Piston black/ steel powder-coated	BPW mit Conti 940MB	03.139.39.48.0	D=201 H=145	

PL-number	pf./ applicable for	OE-Ref.	Dimension	picture
045 000 020				
Rollbalgträger Piston black/ steel powder-coated	BPW mit Conti 4881	03.139.39.49.0	D=251 H=144	

PL-number	pf./ applicable for	OE-Ref.	Dimension	picture
045 000 021				
Rollbalgträger Piston steel	BPW mit Conti 942MB	03.139.00.04.0	D=200 H=203	

PL-number	pf./ applicable for	OE-Ref.	Dimension	picture
045 000 026				
Rollbalgträger Piston black/ steel powder-coated	MAN Bus VA+HA mit Conti916N ÜL-NL-RH-ND-SL-SG NG/ LionsStar-City DD Classic-Coach-Regio Neoplan N4516-20 N1216-17-18/ N2216 N3516/ P05-11-12	81.43603.0062 36.43603.0008	DA=200 DI=125 H=155	

PL-number	pf./ applicable for	OE-Ref.	Dimension	picture
045 000 027				
Rollbalgträger Piston black/ steel powder-coated	MAN Bus HA mit Conti 916N	81.43603.5020	DA=195 DI=130 H=145 2xBolzen M10	

PL-number	pf./ applicable for	OE-Ref.	Dimension	picture
045 000 028				
Rollbalgträger Piston black/ steel powder-coated	MAN mit Conti 916N		DA=195 DI=125 H=155	

PL-number	pf./ applicable for	OE-Ref.	Dimension	picture
045 000 029				
Rollbalgträger Piston black/ steel powder-coated	MAN Bus VA SL-SR-SÜ-SG/ A56-81 mit Conti 715N	81.43603.6021 81.43603.0047 81.43603.6042 81.43603.6055	DA=225 DI=150 H=140	

PL-number	pf./ applicable for	OE-Ref.	Dimension	picture
045 000 030				
Rollbalgträger Piston black/ steel powder-coated	MAN		DA=225 DI=125 H=140 2xBolzen M10	

PL-number	pf./ applicable for	OE-Ref.	Dimension	picture
045 000 032				
Rollbalgträger Piston black/ steel powder-coated	Scania Irizar mit Conti 987N		D1=205 D2=147 H1=168 H2=175	

PL-number	pf./ applicable for	OE-Ref.	Dimension	picture
045 000 034				
Rollbalgträger Piston aluminium	MAN Bus Neoplan VA-HA-NA axle number 1-2-3 mit/ with Conti 916N1	81.43603.0055	D=210 H=149	

PL-number	pf./ applicable for	OE-Ref.	Dimension	picture
045 000 035				
Rollbalgträger Piston aluminium	MAN Bus Neoplan MAN Truck TGA HA/ rear axle mit/ with Conti 916N1	81.43603.0044	D=190 H=149	

PL-number	pf./ applicable for	OE-Ref.	Dimension	picture
045 000 036				
Rollbalgträger Piston black/ steel powder-coated	MB Bus O345		D1=204 D2=131 H=116	

PL-number	pf./ applicable for	OE-Ref.	Dimension	picture
045 000 037				
Rollbalgträger Piston black/ steel powder-coated	MB Bus O550Ü VA/ front axle mit/ with 661N	315.23.10.113.01	D=230 H=152	

PL-number	pf./ applicable for	OE-Ref.	Dimension	picture
045 000 038				
Rollbalgträger Piston black/ steel powder-coated	O405N-GN VA sowie HA front and rear axle	357 320 11 34		

PL-number	pf./ applicable for	OE-Ref.	Dimension	picture
045 000 039				
Rollbalgträger Piston aluminium	MAN Bus mit Conti 884N		D=190 H=131	

PL-number	pf./ applicable for	OE-Ref.	Dimension	picture
045 000 040				
Rollbalgträger Piston black/ steel powder-coated	Volvo mit Conti 644N	1137071 3027878	D=210 H=130	

PL-number	pf./ applicable for	OE-Ref.	Dimension	picture
045 000 045				
Rollbalgträger Piston black/ steel powder-coated	Volvo	20535874	D=182 H=118	

PL-number	pf./ applicable for	OE-Ref.	Dimension	picture
045 000 046				
Rollbalgträger Piston black/ steel powder-coated	Volvo Bus B7L B7L-DD/ B9S/ B9TL	20535873		

PL-number	pf./ applicable for	OE-Ref.	Dimension	picture
045 000 050				
Rollbalgträger Piston steel	MB Citaro HA+NA mit Conti 946N	628 320 03 18 628 320 01 18	D=206 H=150	

PL-number	pf./ applicable for	OE-Ref.	Dimension	picture
045 000 051				
Rollbalgträger Piston steel	MB Citaro VA mit Conti 946N	628 320 00 18		

PL-number	pf./ applicable for	OE-Ref.	Dimension	picture
045 000 052				
Rollbalgträger Piston black/ steel powder-coated	mit Conti 916N MAN Bus LionsCity LionsClassic-Star LionsRegio-Coach Neoplan N2216 N2216-3/ P11-12-26-27 N3616/ 3516-3	81.43603.0075 36.43603.0009	D1=210 D2=260 H=220	

PL-number	pf./ applicable for	OE-Ref.	Dimension	picture
045 000 054				
Rollbalgträger Piston steel	MAN (Achse V9.75L) mit Conti 882N1	81.43603.0060 36.43603.0011	D=190 H=147	

PL-number	pf./ applicable for	OE-Ref.	Dimension	picture
045 000 055				
obere Platte upper plate	Volvo Bus B7R/ B9R B10M/ B11R/ B12 B12M/ B12B/ B12CH Volvo Truck F10-12 mit Conti RZ415-28	1197370	D=150 Anschluss H=25 M16x1,5	

PL-number	pf./ applicable for	OE-Ref.	Dimension	picture
045 000 056				
obere Platte upper plate	Volvo mit Conti 644N	3027910	D=150 Anschluss H=65 M16x1,5	

PL-number	pf./ applicable for	OE-Ref.	Dimension	picture
045 000 057				
obere Platte upper plate	Volvo Bus B10R/ B12 mit Conti 644N	3027911	D=150 Anschluss H=150 M16x1,5	

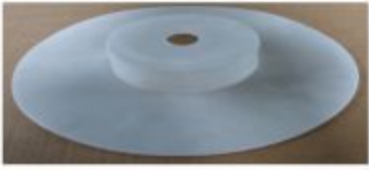
PL-number	pf./ applicable for	OE-Ref.	Dimension	picture
045 001 000				
Isolierteller isolated creator	Conti 661N/ 662N	1101 661 5		

PL-number	pf./ applicable for	OE-Ref.	Dimension	picture
045 001 001				
Anschlaggummi rubber stop	644N 661N 662N	36.96020.0004	DA=97 DI1=28 DI2=18 H=100	

PL-number	pf./ applicable for	OE-Ref.	Dimension	picture
045 001 002				
Schraube zur Befestigung des Anschlaggummi screw for rubber stop	644N 661N 662N	06.02099.0199	M12x40	

PL-number	pf./ applicable for	OE-Ref.	Dimension	picture
045 001 003				
Anschlaggummi rubber stop	MAN Bus LionsCity NG-NL-NM-NÜ	81.96020.0327	DA=110 DI=30 H=76	



PL-number	pf./ applicable for	OE-Ref.	Dimension	picture



PL-number	pf./ applicable for	OE-Ref.	Dimension	picture
644N.8				
Luftbalg Air-Bellow	Conti 644N MB Bus VA+HA Setra HA Neoplan Daf Bus Iveco Bus VanHool Volvo Bus & Truck BPW	000 327 01 01 327 328 00 01 4.771.441.000 4.771.143.000 4.771.170.000 0689677 624319610 624319420 1134445 02.200.24.40.0	DA=210-210 DI=130-130 H=395	



PL-number	pf./ applicable for	OE-Ref.	Dimension	picture
916N.8				
Luftbalg Air-Bellow	Conti 916N MAN Truck & Bus	81.43601.0126 81.43601.0095 81.43601.0105 81.43601.0097 81.43601.0102	DA=240-190 DI=131-131 H=460	



PL-number	pf./ applicable for	OE-Ref.	Dimension	picture
661N.8				
Luftbalg Air-Bellow	Conti 661N Setra VA Neoplan VA VanHool Bus Volvo Truck & Bus Iveco Truck & Bus Renault Bus MAN	4.771.427.000 4.771.427.000 4.771.440.000 4.731.042.000 4.731.031.000 81.43601.0144 624319690 624319670 1137888 41822247 4746733	DA=240-240 DI=151-151 H=391	

PL-number	pf./ applicable for	OE-Ref.	Dimension	picture
662N.8				
Luftbalg Air-Bellow	Conti 662N MAN Neoplan HA VDL Daf Iveco-Magirus BPW	81.43601.0024 81.43601.0018 81.43601.0051 1021 003 00 0578361 03422596 02.200.24.60.0	DA=300-300 DI=198-198 H=360	

PL-number	pf./ applicable for	OE-Ref.	Dimension	picture
4644N.8				
Luftbalg Air-Bellow	Conti 4644N Conti 4644N P02 Conti 644N P02 MB Bus Citaro O350 Turismo O580 Travego	629 327 00 01 629 320 00 25 0501 209 514	DA=210-210 DI=130-M24 H=395 	

PL-number	pf./ applicable for	OE-Ref.	Dimension	picture
946N.8				
Luftbalg Air-Bellow	Conti 946N MB Bus Citaro EvoBus	628 323 00 92	DA=230 DI=131-131 H=435 	

PL-number	pf./ applicable for	OE-Ref.	Dimension	picture
809N.8				
Luftbalg Air-Bellow	Conti 809N Conti 809NT Conti 809NTB MAN Bus	81.43601.0025 81.43601.6002 81.43601.6029 81.43601.6023 81.43601.6030	DA=254 DI=190-11 H=395 	

PL-number	pf./ applicable for	OE-Ref.	Dimension	picture
884N.8				
Luftbalg Air-Bellow	Conti 884N MAN Bus Iveco Irisbus Iveco	81.43601.0066 81.43601.0068 81.43601.0108 81.43601.0106 81.43601.0069 008188539 Iveco 5010294385	DA=230-230 DI=131-131 H=420 	

PL-number	pf./ applicable for	OE-Ref.	Dimension	picture
RZ415-25.8				
Luftbalg Air-Bellow	Conti RZ415-25 Volvo Bus B10M	3027271	DA=221-221 DI=151-131 H=345	

PL-number	pf./ applicable for	OE-Ref.	Dimension	picture
RZ415-28.8				
Luftbalg Air-Bellow	Conti RZ415-28 Volvo Bus B10M/ B10B	3027272	DA=221-221 DI=151-131 H=410	

PL-number	pf./ applicable for	OE-Ref.	Dimension	picture
RZ450-25.8				
Luftbalg Air-Bellow	Conti RZ450-25 MB Bus O404 Iveco Bus	356 327 00 01 356 327 02 01 93197594	DA=221-221 DI=151-151 H=394	

PL-number	pf./ applicable for	OE-Ref.	Dimension	picture
720N.8				
Luftbalg Air-Bellow	Conti 720N MB Truck MAN Truck & Bus Iveco Bus Neoplan Volvo Truck	387 328 01 01 81.43601.0036 81.43601.0033 81.43601.0037 1590136	DA=240-240 DI=131-131 H=460	

PL-number	pf./ applicable for	OE-Ref.	Dimension	picture
673N.8				
Luftbalg Air-Bellow	Conti 673N MB Truck EvoBus Magirus VanHool Volvo Daf Truck	383 327 00 01 02491566 624319860 1611776 0637584	DA=240-240 DI=131-131 H=370	

PL-number	pf./ applicable for	OE-Ref.	Dimension	picture
701N.8				
Luftbalg Air-Bellow	Conti 701N Taurus B116 Bova Bus Ikarus Bus	B510040	DA=260-260 DI=179-179 H=350	

PL-number	pf./ applicable for	OE-Ref.	Dimension	picture
706N.8				
Luftbalg Air-Bellow	Conti 706N MAN Truck	81.43601.0139 81.43601.0096 81.43601.0098 81.43601.0101	DA=240-240 DI=131-131 H=510	

PL-number	pf./ applicable for	OE-Ref.	Dimension	picture
715N.8				
Luftbalg Air-Bellow	Conti 715N MB Truck MAN Bus Daf Truck Irisbus Iveco Iveco Bus Magirus Scania	363 328 00 01 81.43601.0059 81.43601.0060 81.43601.0078 81.43601.0081 81.43601.0113 81.43601.0117 659561 5000819517 4456111	DA=265-265 DI=151-151 H=350	

PL-number	pf./ applicable for	OE-Ref.	Dimension	picture
716N.8				
Luftbalg Air-Bellow	Conti 716N MAN Truck Volvo Truck	81.43601.0039 81.43601.0040 1593842	DA=265-265 DI=131-131 H=460	

PL-number	pf./ applicable for	OE-Ref.	Dimension	picture
719N.8				
Luftbalg Air-Bellow	Conti 719N Neoplan Daf Truck Setra Schmitz Kögel Gigant BPW	0818225 Daf 4.731.032.000 750215 4.731.032.000 196036 02.200.24.00.0	DA=300-300 DI=198-198 H=540	

PL-number	pf./ applicable for	OE-Ref.	Dimension	picture
727N.8				
Luftbalg Air-Bellow	Conti 727N MAN Bus VanHool Bus Daf Truck & Bus Volvo Bus	81.43601.0056 81.43601.0057 81.43601.0058 81.43601.0076 81.43601.0079 81.43601.0082 81.43601.0114 81.43601.0082 81.43601.0114 624319640 0638148 1134446	DA=300-300 DI=198-198 H=45	

PL-number	pf./ applicable for	OE-Ref.	Dimension	picture
746N.8				
Luftbalg Air-Bellow	Conti 746N MB Truck	318 328 00 01	DA=265-265 DI=131-131 H=460	

PL-number	pf./ applicable for	OE-Ref.	Dimension	picture
762N.8				
Luftbalg Air-Bellow	Conti 762N Setra Daf Truck Neoplan MAN Truck BPW Gigant	4.731.013.000 0644425 1021 003 00 81.43601.0049 81.43601.0052 02.200.24.20.0 196035	DA=300-300 DI=198-198 H=390	

PL-number	pf./ applicable for	OE-Ref.	Dimension	picture
768N.8				
Luftbalg Air-Bellow	Conti 768N MAN Truck RVI Bus FR1 Volvo Iris Bus Iveco	81.43601.0053 5000786516 5000954175 1612455 5000786516 5000954175	DA=265-265 DI=131-131 H=385	

PL-number	pf./ applicable for	OE-Ref.	Dimension	picture
769N.8				
Luftbalg Air-Bellow	Conti 769N RVI Iris Bus Iveco Scania Truck VanHool	5000805284 5000785792 5000786640 5000786641 5000805999 624319860	DA=190-190 DI=131-131 H=380	

PL-number	pf./ applicable for	OE-Ref.	Dimension	picture
775N.8				
Luftbalg Air-Bellow	Conti 775N BPW Achsen Koegel Anhänger	0220024700 4.731.040.000	DA=300-300 DI=198-198 H=685	

PL-number	pf./ applicable for	OE-Ref.	Dimension	picture
782N.8				
Luftbalg Air-Bellow	Conti 775N Iris Bus Iveco RVI Renault Renault Bus Tracer/ FR1	5000954176 5000869179 5000787632 5010151699 (782MB-2) 5010673847	DA=210-210 DI=131-131 H=412	

PL-number	pf./ applicable for	OE-Ref.	Dimension	picture
786N.8				
Luftbalg Air-Bellow	Conti 786N EvoBus Iris Bus Iveco	000 328 00 01 5000288982	DA=200-200 DI=101-101 H=355	

PL-number	pf./ applicable for	OE-Ref.	Dimension	picture
788N.8				
Luftbalg Air-Bellow	Conti 788N MB Truck Neoplan VanHool Volvo	393 328 01 01 624319560 6782726	DA=178-178 DI=131-131 H=438	

PL-number	pf./ applicable for	OE-Ref.	Dimension	picture
810N.8				
Luftbalg Air-Bellow	Conti 810N MAN Bus	81.43601.0042 (810N) 81.43601.0047 (810NT) 81.43601.6019 (810NTB)	D=265-265 H=432	

PL-number	pf./ applicable for	OE-Ref.	Dimension	picture
810MB.8				
Luftbalg Air-Bellow	Conti 810MB Volvo Daf Truck RVI Renault ROR Meritor SAF Achsen	1080707 1384273 5000452939 21208082 21215632 2228000200 2228240200 2228260200 2228220200 2228210200	D=265-156,5 H=435	

PL-number	pf./ applicable for	OE-Ref.	Dimension	picture
811NT.8				
Luftbalg Air-Bellow	Conti 811NT EvoBus MAN Bus	4.731.029.000 81.43601.0048 81.43601.0035	D=265 H=508	

PL-number	pf./ applicable for	OE-Ref.	Dimension	picture
811MB.8				
Luftbalg Air-Bellow	Conti 811MB EvoBus Daf Truck RVI Renault	4.731.029.000 (811N) 1384274 0067306 (811M) 0676122 (811M) 5000745918	D=286-200 D=260-200 H=178	

PL-number	pf./ applicable for	OE-Ref.	Dimension	picture
813MB.8				
Luftbalg Air-Bellow	Conti 813MB EvoBus RVI Renault SAF Sauer axle Trailer Scania Truck P92 Ayats Bus ROR Meritor	4.731.030.000 4.731.033.000 5010130925 5000790692 2229000300 0036158E 65022347Y 65023482 21215633	D=265-156,5 H=511	

PL-number	pf./ applicable for	OE-Ref.	Dimension	picture
817N				
Luftbalg Air-Bellow	Conti 817N Bova Bus RVI Renault	B180784 (817MB) 5810111355 (817MB) 5000786641 5000805998 (817N) 5810111355 (817N)	DA=220-220 DI=131-101 H=309	

PL-number	pf./ applicable for	OE-Ref.	Dimension	picture
819N.8				
Luftbalg Air-Bellow	Conti 819N MB Vario	000 328 01 01 (819N) 667 328 00 01 (819NP01) 667 328 01 01 (819MB)	DA=160 DI=101 H=345	

PL-number	pf./ applicable for	OE-Ref.	Dimension	picture
822N.8				
Luftbalg Air-Bellow	Conti 822N Iveco Bus315	4680913	D=200 H=290	

PL-number	pf./ applicable for	OE-Ref.	Dimension	picture
838N.8				
Luftbalg Air-Bellow	Conti 838N MB Truck	674 328 00 01	DA=265 DI=131 H=595	

PL-number	pf./ applicable for	OE-Ref.	Dimension	picture
873N.8				
Luftbalg Air-Bellow	Conti 873N MB Truck	674 328 01 01	DA=240 DI=131 H=595	

PL-number	pf./ applicable for	OE-Ref.	Dimension	picture
876N.8				
Luftbalg Air-Bellow	Conti 876N Iris Bus Iveco RVI Renault Ayats Bus	5000296816 5000640399 (876MB) 5000738516 (876MB)	DA=240-240 DI=151-151 H=470	

PL-number	pf./ applicable for	OE-Ref.	Dimension	picture
879N.8				
Luftbalg Air-Bellow	Conti 879N Bova Bus Iveco Bus RVI Renault	B184139 4681868	D=200 H=247	

PL-number	pf./ applicable for	OE-Ref.	Dimension	picture
882N.8				
Luftbalg Air-Bellow	Conti 882N1 MB Truck MAN Truck	658 328 01 01 81.43601.0065 81.43601.0067 81.43601.0070 81.43601.0092 81.43601.0099 81.43601.0103 81.43601.0121 81.43601.0132	DA=210-210 DI=131-102 H=465	

PL-number	pf./ applicable for	OE-Ref.	Dimension	picture
883N1.8				
Luftbalg Air-Bellow	Conti 883N1 MAN Truck	81.43601.0071 81.43601.0072 81.43601.0110 81.43601.0128	DA=230-230 DI=131-13 H=495	

PL-number	pf./ applicable for	OE-Ref.	Dimension	picture
896N.8				
Luftbalg Air-Bellow	Conti 896N Scania Dennis Bus	411627 473049 6563002	DA=190-190 DI=121-121 H=510	

PL-number	pf./ applicable for	OE-Ref.	Dimension	picture
897N.8				
Luftbalg Air-Bellow	Conti 897N Scania Pegaso Dennis Bus VDL Daf Bus	411627 411623 402315 795097 794686 6562892 1152197 1153935 1154761	DA=220-220 DI=165-165 H=425	

PL-number	pf./ applicable for	OE-Ref.	Dimension	picture
909NT.8				
Luftbalg Air-Bellow	Conti 909NT MAN Truck Neoplan	81.43601.0050 81.43601.0054 81.43601.0073 81.43601.6029 81.43601.6023 (909NTB) 1021 005 00 1021 215 00	D=254 H=365	

PL-number	pf./ applicable for	OE-Ref.	Dimension	picture
921N.8				
Luftbalg Air-Bellow	Iris Bus Iveco RVI Renault	5000288982 5010151379 (921MB) 5010151379 (921MB)	DA=190-190 DI=131-131 H=410	

PL-number	pf./ applicable for	OE-Ref.	Dimension	picture
927N.8				
Luftbalg Air-Bellow	Volvo Leyland Dennis Bus VDL Jonckheere Scania K82-112	3116354 AAU2542 6562992 611896/12	DA=185-185 DI=121-121 H=425	

PL-number	pf./ applicable for	OE-Ref.	Dimension	picture
928N.8				
Luftbalg Air-Bellow	Volvo Olympian Iveco Bus Scania K92-93 Schmitz Anhänger	3116983 6453741 434932 750212	DA=220-220 DI=165-165 H=375)	

PL-number	pf./ applicable for	OE-Ref.	Dimension	picture
936N.8				
Luftbalg Air-Bellow	RVI Renault Bus R312	5000819370	DA=220-220 DI=151-151 H=350	

PL-number	pf./ applicable for	OE-Ref.	Dimension	picture
943N.8				
Luftbalg Air-Bellow	Inbus Iveco Fiat Truck	5001051 6144040 8160165	DA=216-216 DI=131-131 H=290	

PL-number	pf./ applicable for	OE-Ref.	Dimension	picture
944N.8				
Luftbalg Air-Bellow	Iveco Bus Iveco Fiat Truck VDL Daf Daf Truck Inbus	4714025 4722525 6657150 4738008 8188526 0627584 4840005	DA=216-216 DI=131-131 H=390	

PL-number	pf./ applicable for	OE-Ref.	Dimension	picture
945N.8				
Luftbalg Air-Bellow	Iveco Bus Iveco Fiat Truck Scania Bus	4716889 0501 312 548	DA=216-216 DI=131-131 H=435	

PL-number	pf./ applicable for	OE-Ref.	Dimension	picture
975N.8				
Luftbalg Air-Bellow	Conti 975N EvoBus ZF Van Outsen DAB-Bus	699 328 01 01 8.252.054.212 0501 312 548	DA=140-140 DI=81-82 H=320	

PL-number	pf./ applicable for	OE-Ref.	Dimension	picture
1415N.8				
Luftbalg Air-Bellow	Conti 1515N Iris Bus Agora/ Crystalis	5001021414 (1415N) 5006172377 (1415NP01) 5006172527 (1415NP02)	DA=225-225 DI=151-131 H=322	

PL-number	pf./ applicable for	OE-Ref.	Dimension	picture
1782N1.8				
Luftbalg Air-Bellow	Conti 782N Conti 1782N1 Iris Bus Illiade/ Ares Karosa	5001857612 5010531180	DA=230-230 DI=151-131 H=460	

PL-number	pf./ applicable for	OE-Ref.	Dimension	picture
1876N.8				
Luftbalg Air-Bellow	Conti 1876NP01 Renault Magnum	5010239072 (1876N) 5010239072 (1876NP01)	DA=240-240 DI=151-151 H=470	

PL-number	pf./ applicable for	OE-Ref.	Dimension	picture
1885N.8				
Luftbalg Air-Bellow	Conti 1885N Iris Bus Iveco Fiat Truck MAN Truck	5001843640 98478799 81.43601.0125 81.43601.0140	DA=230-230 DI=131-131 H=445	





PL-number	pf./ applicable for	OE-Ref.	Dimension	picture
1924N1.8				
Luftbalg Air-Bellow	Conti 1924N1 Iris Bus Agora/ Crystalis Volvo	5001843640 1075366	DA=230-230 DI=151-131 H=360	





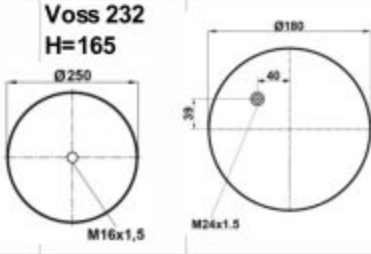
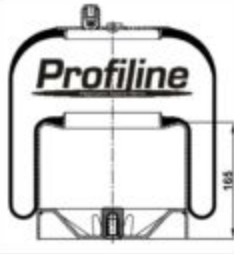
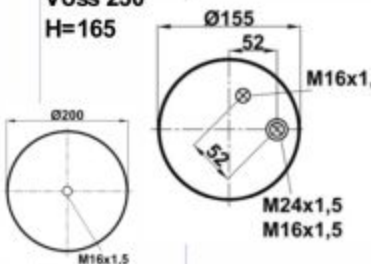

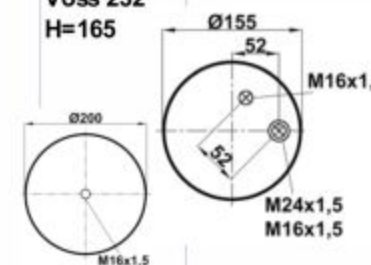

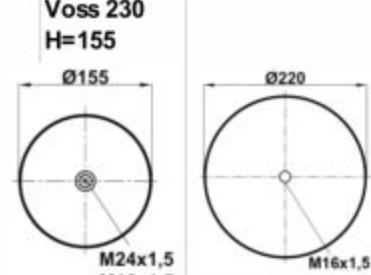
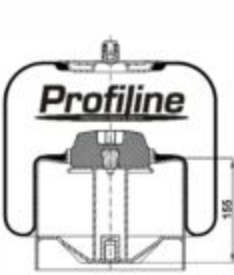
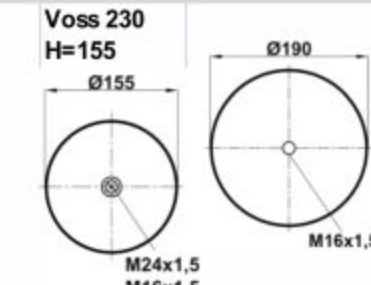
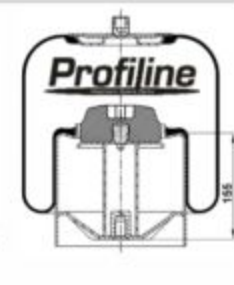

PL-number	pf./ applicable for	OE-Ref.	Dimension	picture
4154NP05.8				
Luftbalg Air-Bellow	Conti 4154NP05 Renault Truck Magnum Premium	5010294252 5010239252	DA=241 DI=200 H=120	

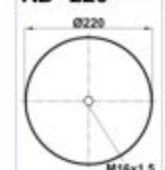
PL-number	pf./ applicable for	OE-Ref.	Dimension	picture
4183NP23.8				
Luftbalg Air-Bellow	Conti 4183NP23 MB Truck Actros MP1-2	942 320 22 21 942 320 68 21 942 320 13 21	Voss 232 H=165	

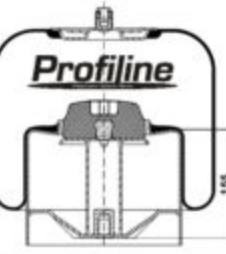
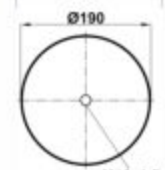
PL-number	pf./ applicable for	OE-Ref.	Dimension	picture
4183NP24.8				
Luftbalg Air-Bellow	Conti 4183NP24 MB Truck Actros MP1-2	942 320 23 21 942 320 69 21 942 320 14 21	Voss 232 H=165	

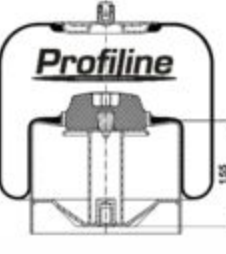
PL-number	pf./ applicable for	OE-Ref.	Dimension	picture
4185NP01.8				
Luftbalg Air-Bellow	Conti 4185N MB Truck Atego	974 328 02 01 (4185N) 974 320 00 21 (4185NP01) 942 320 30 21 (4185NP01)	Voss 230 H=165	

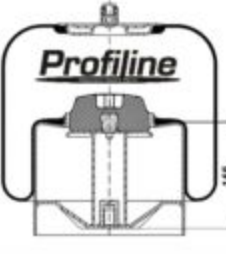
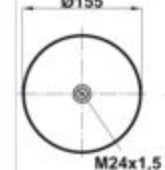

PL-number	pf./ applicable for	OE-Ref.	Dimension	picture
4185NP21.8				
Luftbalg Air-Bellow	Conti 4185NP21	942 320 30 21 974 320 00 21	Voss 232 H=165 	
4390NP02.8				
Luftbalg Air-Bellow	Conti 4390NP02 MB Truck Actros MP1-2	942 320 02 21 942 320 29 21 942 320 50 21	Voss 230 H=165 	
4390NP22.8				
Luftbalg Air-Bellow	Conti 4390NP22 MB Truck Actros MP1-2	942 320 02 21 942 320 29 21 942 320 50 21	Voss 232 H=165 	
4737NP01.8				
Luftbalg Air-Bellow	Conti 4737NP01 MB Truck Atego	946 320 03 21 942 320 37 21	Voss 230 H=155 	
4737NP02.8				
Luftbalg Air-Bellow	Conti 4737NP02 MB Truck Atego	946 320 05 21 942 320 39 21	Voss 230 H=155 	

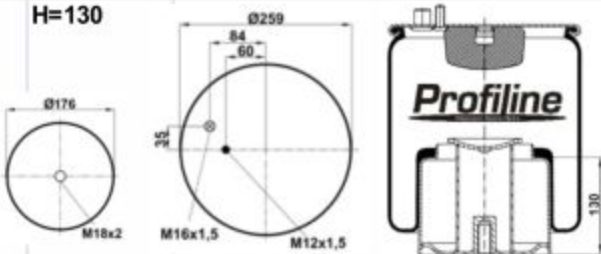
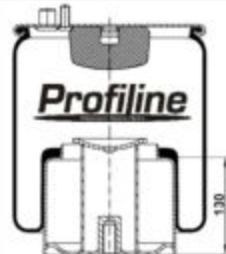

PL-number	pf./ applicable for	OE-Ref.	Dimension	picture
4737NP05.8				
Luftbalg Air-Bellow	Conti 4737NP05 MB Truck Atego/ Econic	957 320 01 17 957 320 03 17	Voss 232 H=155 KD=280 	 M24x1,5 M16x1,5 
4737NP21.8				
Luftbalg Air-Bellow	Conti 4737NP21 MB Truck Atego	946 320 03 21 942 320 37 21	Voss 232 H=155 KD=220 	 M24x1,5 M16x1,5 
4737NP22.8				
Luftbalg Air-Bellow	Conti 4737NP22 MB Truck Atego	942 320 39 21 946 320 05 21	Voss 232 H=155 KD=190 	 M24x1,5 M16x1,5 
4737NP25.8				
Luftbalg Air-Bellow	Conti 4737NP25 MB Truck Atego/ Econic	957 320 01 17 957 320 03 17	Voss 232 H=155 KD=280 	 M24x1,5 M16x1,5 
4757NP01.8				
Luftbalg Air-Bellow	Conti 4757NP01 MB Truck Actros	942 320 01 17 942 320 43 21	Voss230 H=155  M24x1,5 M16x1,5  M16x1,5	

PL-number	pf./ applicable for	OE-Ref.	Dimension	picture
4757NP21.8				
Luftbalg Air-Bellow	Conti 4757NP01 MB Truck Actros MP1	942 320 43 21 942 320 01 17	H=155 Ø155 Ø280 M24x1,5 M16x1,5	
4757NP29.8				
Luftbalg Air-Bellow	Conti 4757NP29 MB Truck Actros/ Atego	942 320 32 21 974 320 02 17 974 320 04 17	Voss 232 H=155 Ø155 52 M24x1,5 M16x1,5	
4786NP01.8				
Luftbalg Air-Bellow	Conti 4786NP01 MB Truck Atego	942 320 01 17	Voss 230 D=121 H=324 Ø155 52 M24x1,5 M16x1,5 (VOSS 230)	
4786NP01.8				
Luftbalg Air-Bellow	Conti 4786NP21 MB Truck Atego	942 320 45 12	Voss 232 H=114 KD=119 Ø155 52 M24x1,5 M16x1,5 (VOSS 232)	
4813NP07.8				
Luftbalg Air-Bellow	Conti 4154NP07 Scania Truck (R93/ 133-142-143)	255295 325748 298568 255293 1107674 1314906	DA=265 DI=158,5 H=511 Ø286 M14x1,5 158,5 158,5 4xM10	

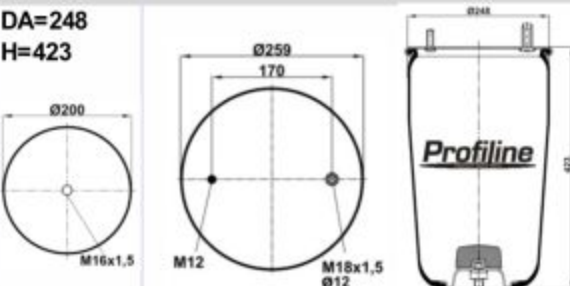
PL-number	pf./ applicable for	OE-Ref.	Dimension	picture
4882N1P01.8				
Luftbalg Air-Bellow	Conti 4882N1P01 MAN Truck TGA	81.43601.0151	DA=220 DI=130,8 H=513 Ø155 M24x1,5	
4882N1P05.8				
Luftbalg Air-Bellow	Conti 4882N1P05 MAN Truck TGA	81.43601.6036	H=116 Ø259 84 60 70 2xM16x1,5 M12x1,5 Ø176 M18x2	
4913NP02.8				
Luftbalg Air-Bellow	Conti 4913NP02 Scania Truck Serie4	1379392 1440294 1379393	H=210 Ø230 Ø15 M16 M16x1,5 2xØ12 Ø286 177 144	
4916N1P07.8				
Luftbalg Air-Bellow	Conti 4916N1P07 MAN Truck TGA	81.43600.6042	H=150 Ø210 Ø273,5 84 60 30 M16x1,5 M12x1,5	
4885N1P01.8				
Luftbalg Air-Bellow	Conti 4885N1P01 MAN Truck L2000	81.43601.0160 81.43601.6071	DA=220 DI=131 H=408 Ø259 84 60 M16x1,5 M12x1,5	

PL-number	pf./ applicable for	OE-Ref.	Dimension	picture
4885N1P02.8				
Luftbalg Air-Bellow	Conti 4885N1P02 MAN Truck L2000	81.43600.6044	H=130 	

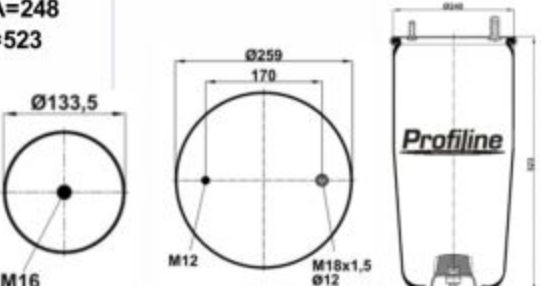
PL-number	pf./ applicable for	OE-Ref.	Dimension	picture
4940NP02.8				
Luftbalg Air-Bellow	Conti 940N Conti 4940N02 BPW Achsen	0542940910	DA=248 H=423 	

PL-number	pf./ applicable for	OE-Ref.	Dimension	picture
4941NP02.8				
Luftbalg Air-Bellow	Conti 4941NP02 BPW Achsen	0542940030	DA=248 H=523 	

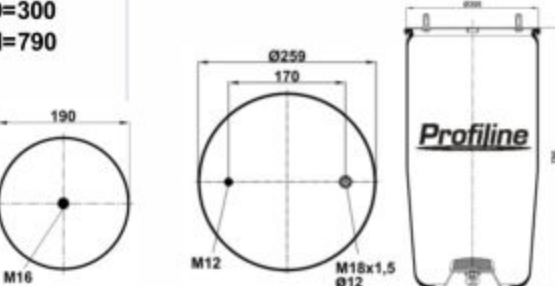
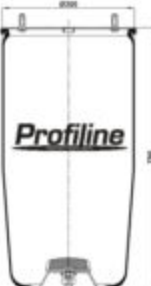
PL-number	pf./ applicable for	OE-Ref.	Dimension	picture
4942NP02.8				
Luftbalg Air-Bellow	Conti 4942NP02 BPW Achsen	0542940050	D=300 H=790 	

PL-number	pf./ applicable for	OE-Ref.	Dimension	picture

QUALITY AND WARRENTY CERTIFICATE !!!

our terms of business are defined in our homepage www.profiline.com

The owner of the brand "Profiline Kleemann" assures failsafe operation, long service life of all "Profiline Kleemann" spare parts.

From the initial sample up the final product all quality criterias will be considered, regular inspections and random functionality tests of our products as well as a professional warehousing ensure that only parts of best quality leave the warehouse.

Insofar as nothing to the contrary is expressly agreed to, the owner of "Profiline Kleemann" provides a warranty for freedom from defects of the delivered parts for a duration of 12 months, commencing date = date of invoice. In case a material or manufacturing defect should occur we will replace the defective "Profiline Kleemann" product free of charge at anytime during the warranty period, an possible defect has to report to the owner of the brand "Profiline Kleemann" right after arise.

As far as repairs are possible the right to replace the defective parts is waived. Under certain circumstances the owner of "Profiline Kleemann" may offer his assistance for labour reimbursement when due to the failure of a "Profiline Kleemann" part collateral damages occur.

These cases will be handled on a case by case basis only and should be notified in writing withim a period of 1 month.

The conditions of this warranty become invalid if the parts delivered is modified, unless the defect has no causal can use with the modification.

"Profiline Kleemann" products have to be mounted by qualified personel only, the instructions of the vehicle manufacturers have to be followed. Moreover this guarantee excludes wear and tear damages, caused by improper usage.



CHEAP

FAST

RELIABLE



**TWENTY YEARS EXPERIENCE
IN THE AREA OF
BUS AND TRUCK PARTS**

update 06-2017

PROFILINE DELIVERY SPARE PARTS WORLDWIDE