

# PROFILINE

KLEEMANN SPARE PARTS

Germany



German quality repair and accessories parts

## BODY PARTS FOR BUSES



[www.profiline.com](http://www.profiline.com)

So erreichen Sie uns/ contact to us

## Verkauf/ Sales

phone: +49 33056/ 2873 -10/ -11

telefax: +49 33056/ 2873-33

mail: sales@profiline.com

## Gewährleistungen/ Warrenty

phone: +49 33056/ 2873 -11

telefax: +49 33056/ 2873-33

## Buchhaltung/ Accounting

phone: +49 33056/ 2873 -38

telefax: +49 33056/ 2873-39

mail: accounting@profiline.com

## Lager-Versand/ Storekeeper

phone: +49 33056/ 2873 -58/ -59

telefax: +49 33056/ 2873-44

## Geschäftsleitung/ Management

phone: +49 33056/ 2873 -27/ -10

telefax: +49 33056/ 2873-21

mail: kleemann@profiline.com

### Das PROFILINE-Team

Service steht für uns an erster Stelle.

Damit unsere Ersatzteile schnell bei Ihnen sind, achten wir auf eine hohe Verfügbarkeit und stehen Ihnen mit einem zuverlässigen Lieferservice zur Seite-weltweit.

Wir freuen uns auf eine erfolgreiche Zusammenarbeit mit Ihnen.

### The PROFILINE-Team

Service is our number one priority.

So that our replacement parts are fast to you, we pay attention to high availability and are available world-wide with a reliable delivery service.

We look forward to a successful cooperation with you.

## Ersatzteile für LKW und Bus



### MAN Lion's City Frontkarosserie



**Stossecke Rechts**  
OE Vgl.-Nr. 88.79201.5020  
PL Nr. 099 110 067

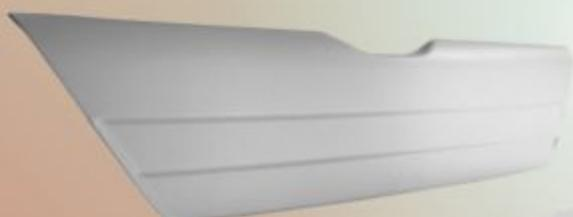

**Frontklappe**  
OE Vgl.-Nr. 88.79201.5023  
PL Nr. 099 110 068



**Stossecke Links**  
OE Vgl.-Nr. 88.79201.5021  
PL Nr. 099 110 066



**Spoiler Unten**  
OE Vgl.-Nr. 88.79201.5022  
PL Nr. 099 110 092

**Heckecke Links**  
OE Vgl.-Nr. 36.73203.5009  
PL Nr. 099 110 157



**Stossstangenmittelteil Heck**  
OE Vgl.-Nr. 88.73203.5009  
PL Nr. 099 110 160

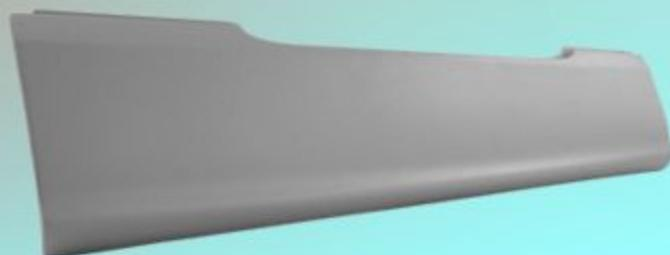

**Heckecke Rechts**  
OE Vgl.-Nr. 36.73203.5008  
PL Nr. 099 110 158



www.profiline.com

## Ersatzteile für LKW und Bus



### MAN Lion's Coach Frontkarosserie R07 / R08 / R09



**Stossecke Front Rechts**  
OE Vgl.-Nr. 36.73201.5032  
PL Nr. 099 110 071



**Frontklappe**  
OE Vgl.-Nr. 81.73201.6132  
PL Nr. 099 110 073



**Stossecke Front Links**  
OE Vgl.-Nr. 36.73201.5033  
PL Nr. 099 110 072



**Stossecke Heck Rechts**  
OE Vgl.-Nr. 36.79201.0044  
PL Nr. 099 110 174



**Verriegelung für Frontklappe**  
OE Vgl.-Nr. 81.97122.0041  
PL Nr. 099 110 175



**Stossecke Heck Links**  
OE Vgl.-Nr. 36.79201.0043  
PL Nr. 099 110 173

## Ersatzteile für LKW und Bus



### MB Travego 0580

#### Frontgrill

OE Vgl.-Nr. 632 880 01 40  
PL Nr. 099 130 074



#### Stossecke Front Rechts

OE Vgl.-Nr. 632 880 13 72  
PL Nr. 099 130 076



#### Stosstange Front

OE Vgl.-Nr. 632 880 01 70  
PL Nr. 099 130 073



#### Stossecke Front Links

OE Vgl.-Nr. 632 880 10 72  
PL Nr. 099 130 075

#### Stossecke Heck Rechts

OE Vgl.-Nr. 632 880 07 72  
PL Nr. 099 130 089

#### Stosstange Heck ohne PP

OE Vgl.-Nr. 632 885 00 05  
PL Nr. 099 130 087

#### Stossecke Heck Links

OE Vgl.-Nr. 632 880 06 72  
PL Nr. 099 130 090



#### Stosstange Heck mit PP

OE Vgl.-Nr. 632 885 01 05  
PL Nr. 099 130 088



## Ersatzteile für LKW und Bus



### MB Tourismo O350 & Integro O550

#### Frontgrill

OE Vgl.-Nr. 632 880 01 40  
PL Nr. 099 130 074



#### Stossecke Front Rechts

OE Vgl.-Nr. 633 880 03 72  
PL Nr. 099 120 025



#### Stosstange Front

OE Vgl.-Nr. 632 880 01 70  
PL Nr. 099 130 073



#### Stossecke Front Links

OE Vgl.-Nr. 633 880 02 72  
PL Nr. 099 120 026

#### Stossecke Heck Rechts

OE Vgl.-Nr. 632 880 07 72  
PL Nr. 099 130 089

#### Stosstange Heck ohne PP

OE Vgl.-Nr. 632 885 00 05  
PL Nr. 099 130 087

#### Stossecke Heck Links

OE Vgl.-Nr. 632 880 06 72  
PL Nr. 099 130 090



#### Stosstange Heck mit PP

OE Vgl.-Nr. 632 885 01 05  
PL Nr. 099 130 088



Profiline Import-Export GmbH

Buchhorsterstr. 23  
16567 Mühlenbeck / Germany

**PROFILINE**  
KLEEMANN SPARE PARTS

Tel: 049 33056/2873-11  
Fax: 049 33056/2873-21  
Mail: kleemann@profiline.com  
www.profiline.com

Ersatzteile für LKW und Bus



MB Travego 0580 & Tourismo 0350

**Bodenkapsel unter Getriebe**

OE Vgl.-Nr. 629 693 09 17  
BP Nr. 099 130 055

**Bodenkapsel Rechts unter Kühler**

OE Vgl.-Nr. 629 693 07 17  
BP Nr. 099 130 052

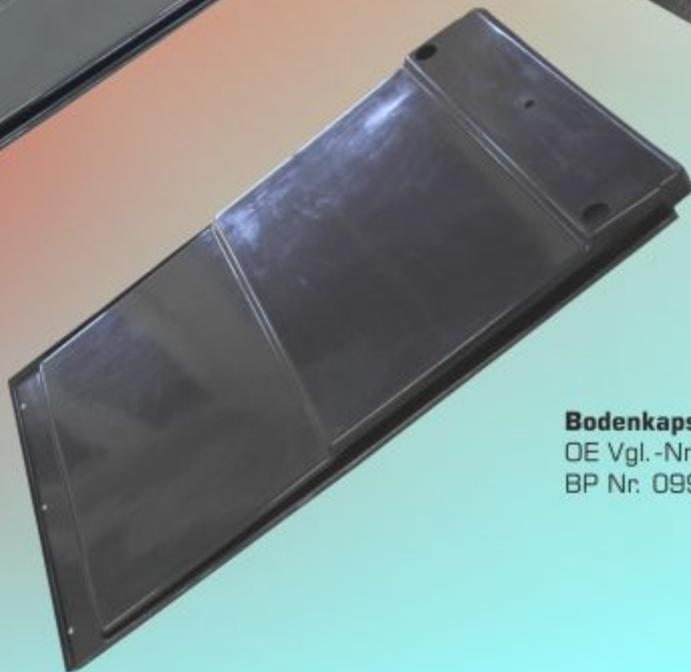

**Bodenkapsel unter Motor**

OE Vgl.-Nr. 629 693 01 17  
BP Nr. 099 130 053

+++ Angebot nur solange der Vorrat reicht +++ Angebot nur solange der Vorrat reicht +++

## Ersatzteile für LKW und Bus



### Setra S400er NF

#### Heckecke Links

OE Vgl.-Nr. 628 885 12 05  
PL Nr. 099 130 012

#### Heckecke Links

OE Vgl.-Nr. 628 885 02 05  
PL Nr. 099 130 012.1

#### Heckecke Rechts

OE Vgl.-Nr. 628 885 03 05  
PL Nr. 099 130 013.1

#### Heckecke Rechts

OE Vgl.-Nr. 628 885 11 05  
PL Nr. 099 130 013



### Setra S400er UL/GT/GT-HD



#### Heckecke Links

OE Vgl.-Nr. 632 880 04 72  
PL Nr. 099 120 335

#### Heckecke Rechts

OE Vgl.-Nr. 632 880 05 72  
PL Nr. 099 120 336



### Setra S400er HD/HDH/ 431DT

#### Heckecke Rechts ohne Parkpilot

OE Vgl.-Nr. 629 880 13 72  
PL Nr. 099 130 032

#### Heckecke Links ohne Parkpilot

OE Vgl.-Nr. 629 880 14 72  
PL Nr. 099 130 033

#### Heckecke Rechts mit Parkpilot

OE Vgl.-Nr. 629 880 17 72  
PL Nr. 099 130 032.1

#### Heckecke Links mit Parkpilot

OE Vgl.-Nr. 629 880 18 72  
PL Nr. 099 130 033.1



## Ersatzteile für LKW und Bus



### Setra S400er NF

**Heckstossstange**

OE Vgl.-Nr: 628 880 47 71  
PL Nr: 099 120 210

**Inkl. Klappen**



### Setra S400er UL/GT/GT-HD

**Heckstossstange**

OE Vgl.-Nr: 632 885 00 02  
PL Nr: 099 130 071

**Inkl. Klappen**



### Setra S400er HD/HDH/ 431DT

**Heckstossstange**

OE Vgl.-Nr: 629 880 04 71  
PL Nr: 099 130 034

**Inkl. Klappen**



Profiline Import-Export GmbH

Buchhorsterstr. 23  
16567 Mühlenbeck / Germany

**PROFILINE**  
KLEEMANN SPARE PARTS

Tel: 049 33056/2873-11  
Fax: 049 33056/2873-21  
Mail: kleemann@profiline.com  
www.profiline.com

Ersatzteile für LKW und Bus



## Setra 400er HD/HDH/GT-HD Serie

### Bodenkapsel Rechts unter Kühler

OE Vgl.-Nr. 629 693 07 17  
PL Nr. 099 130 052



### Bodenkapsel unter Getriebe

OE Vgl.-Nr. 629 693 09 17  
PL Nr. 099 130 055



### Bodenkapsel unter Getriebe

OE Vgl.-Nr. 629 693 00 17  
PL Nr. 099 130 054



### Bodenkapsel unter Motor

OE Vgl.-Nr. 629 693 01 17  
PL Nr. 099 130 053



+++ Angebot nur solange der Vorrat reicht +++ Angebot nur solange der Vorrat reicht +++

Profiline Import-Export GmbH

Buchhorsterstr. 23  
16567 Mühlenbeck / Germany

**PROFILINE**  
KLEEMANN SPARE PARTS

Tel: 049 33056/2873-11  
Fax: 049 33056/2873-21  
Mail: kleemann@profiline.com  
www.profiline.com

Ersatzteile für LKW und Bus



## Setra 400er NF Serie

### Bodenkapsel Vorn Rechts

OE Vgl.-Nr. 628 683 15 08  
PL Nr. 099 120 085

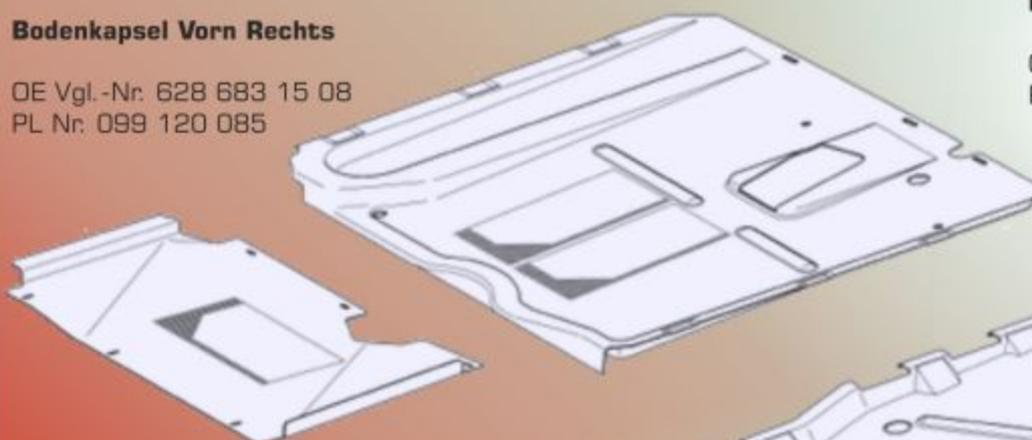

### Bodenkapsel Hinten Rechts

OE Vgl.-Nr. 628 683 45 08  
PL Nr. 099 120 043



### Bodenkapsel Hinten Links

OE Vgl.-Nr. 628 683 23 08  
PL Nr. 099 120 022

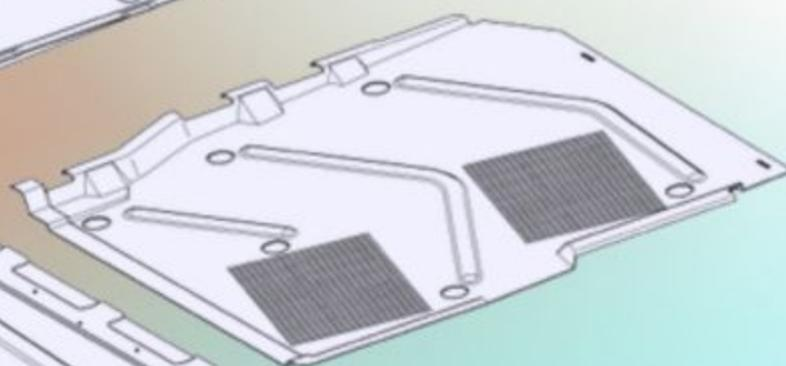

### Bodenkapsel Vorn Links

OE Vgl.-Nr. 628 683 40 08  
PL Nr. 099 120 021

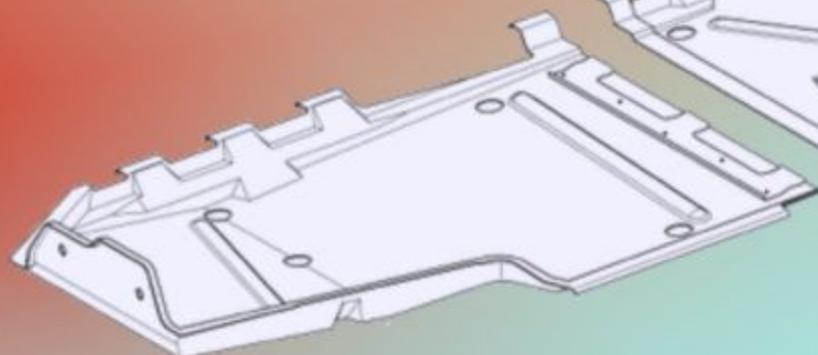

+++ Angebot nur solange der Vorrat reicht +++ Angebot nur solange der Vorrat reicht +++

## Ersatzteile für LKW und Bus



### Setra 400er UL Serie

#### Bodenkapsel Hinten Rechts

OE Vgl.-Nr. 627 690 08 07  
PL Nr. 099 130 067

#### Bodenkapsel Vorn Rechts

OE Vgl.-Nr. 629 693 05 17  
PL Nr. 099 130 065

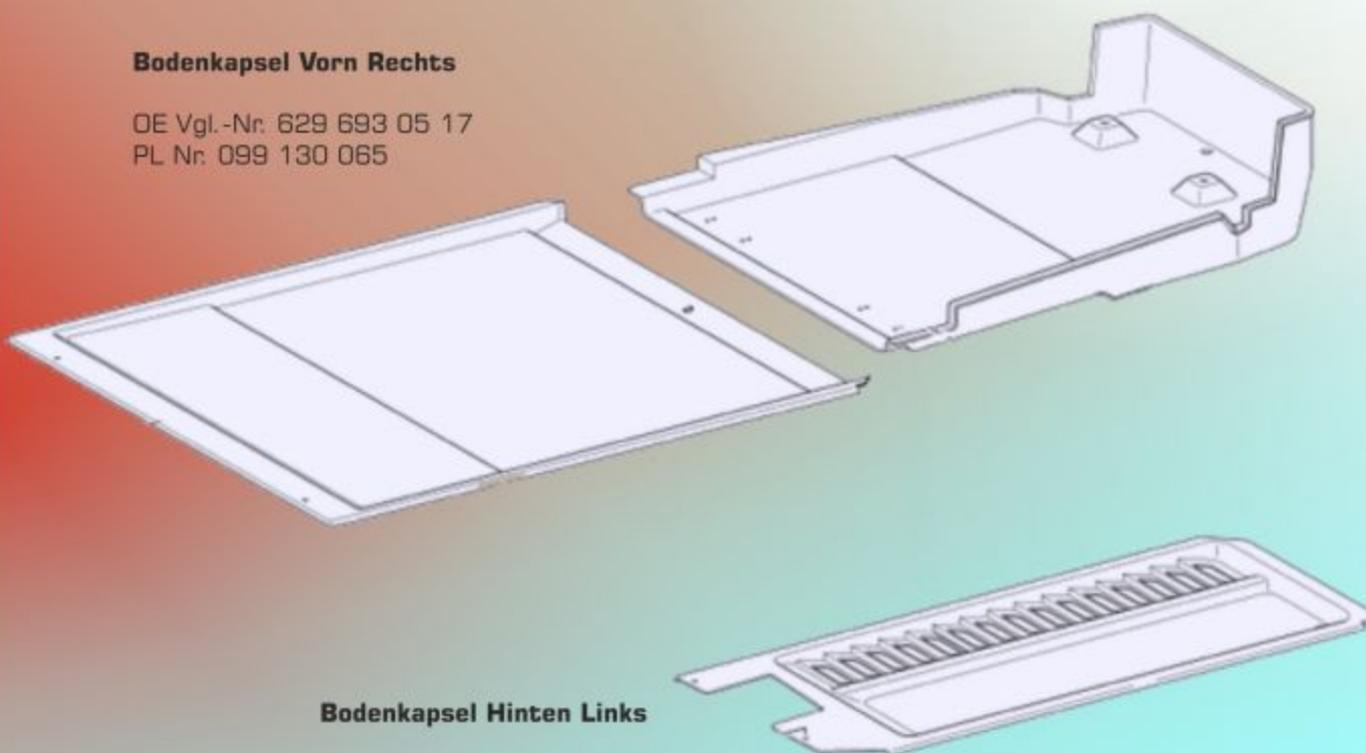

#### Bodenkapsel Hinten Links

OE Vgl.-Nr. 629 693 06 17  
PL Nr. 099 130 066

## Ersatzteile für LKW und Bus



### MB Citaro Euro 2&3 Front



**Stossecke Rechts (ohne Nebelsw.)**

OE Vgl.-Nr. 628 885 02 25  
PL Nr. 099 120 018.1

**Stossecke Links (ohne Nebelsw.)**

OE Vgl.-Nr. 628 885 01 25  
PL Nr. 099 120 015



**Stossecke Rechts (mit Nebelsw.)**

OE Vgl.-Nr. 628 885 04 25  
PL Nr. 099 120 017.1

**Stossecke Links (mit Nebelsw.)**

OE Vgl.-Nr. 628 885 03 25  
PL Nr. 099 120 014



**Stossecke Rechts  
(mit Nebelsw. & Wartungsklappe)**

OE Vgl.-Nr. 628 885 08 25  
PL Nr. 099 120 017



**Stossecke Rechts  
(ohne Nebelsw. & Wartungsklappe)**

OE Vgl.-Nr. 628 885 06 25  
PL Nr. 099 120 018

**Sehr geehrte Kundschaft,  
fahrzeugspezifische Lackierung  
können Sie gerne bei unseren  
Verkaufsberatern anfragen.**

## Ersatzteile für LKW und Bus



### MB Citaro Euro 2&3 Front



**Stossstange unten mit Beschlagteile**  
**Fahrzeugbreite 2500mm**

OE Vgl.-Nr. 628 880 02 70  
PL Nr. 099 120 016

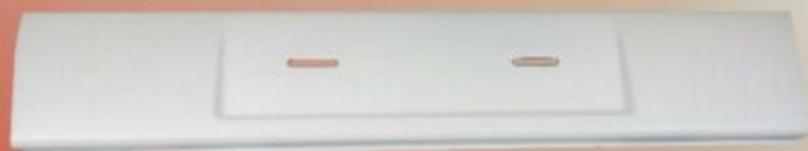

**Stossstange unten ohne Beschlagteile**  
**Fahrzeugbreite 2500mm**

OE Vgl.-Nr. 628 885 01 01  
PL Nr. 099 120 016.3

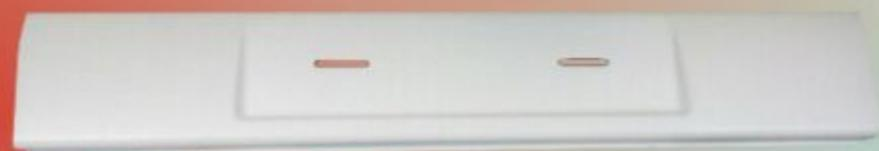

**Stossstange unten mit Beschlagteile**  
**Fahrzeugbreite 2550mm**

OE Vgl.-Nr. 628 880 03 70  
PL Nr. 099 120 016.2

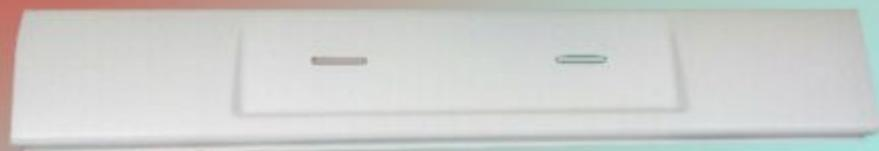

**Stossstange unten ohne Beschlagteile**  
**Fahrzeugbreite 2550mm**

OE Vgl.-Nr. 628 885 02 01  
PL Nr. 099 120 016.1

#### Aufreisschloß für Stossstange

OE Vgl.-Nr. 357 750 01 50  
PL Nr. 099 110 020



## Ersatzteile für LKW und Bus



### MB Citaro Euro 2&3 Front



**Frontklappe Glatt ohne Rippen**

OE Vgl.-Nr. 628 751 11 02  
PL Nr. 099 120 019.1



**Frontklappe mit Rippen & Emblemsicke**

OE Vgl.-Nr. 628 751 01 02  
PL Nr. 099 120 019

**Aufreisschloß für Frontklappe**

OE Vgl.-Nr. 357 750 01 50  
PL Nr. 099 110 020



**Sehr geehrte Kundschaft,  
fahrzeugspezifische Lackierung  
können Sie gerne bei unseren  
Verkaufsberatern anfragen.**

## Ersatzteile für LKW und Bus



### MB Citaro Euro 2&3 Heck



**Stossecke Links  
(Positionsleuchte Einbau)**

OE Vgl.-Nr. 628 885 01 02  
PL Nr. 099 120 103

**Stossecke Rechts  
(Positionsleuchte Einbau)**

OE Vgl.-Nr. 628 885 02 02  
PL Nr. 099 120 104



**Stossecke Links  
(Positionsleuchte Aufbau)**

OE Vgl.-Nr. 628 885 15 02  
PL Nr. 099 120 103.1

**Stossecke Rechts  
(Positionsleuchte Aufbau)**

OE Vgl.-Nr. 628 885 16 02  
PL Nr. 099 120 104.1



**Stossecke Links mit Ausschnitt Abgasrohr  
(Positionsleuchte Einbau)**

OE Vgl.-Nr. 628 885 13 02  
PL Nr. 099 120 103.3



**Sehr geehrte Kundschaft,**



**Stossecke Links mit Ausschnitt Abgasrohr  
(Positionsleuchte Aufbau)**

OE Vgl.-Nr. 628 885 17 02  
PL Nr. 099 120 103.2

**fahrzeugspezifische Lackierung**

**können Sie gerne bei unseren**

**Verkaufsberatern anfragen.**

## Ersatzteile für LKW und Bus



### MB Citaro Euro 2&3 Heck



**Stosstange klappbar 2x Lampenausschnitt**  
**Fahrzeugbreite 2550mm**

OE Vgl.-Nr: 628 880 12 71  
PL Nr: 099 120 101.1



**Stosstange klappbar 2x Lampenausschnitt**  
**Fahrzeugbreite 2500mm**

OE Vgl.-Nr: 628 880 11 71  
PL Nr: 099 120 100.1



**Stosstange klappbar 4x Lampenausschnitt**  
**Fahrzeugbreite 2550mm**

OE Vgl.-Nr: 628 880 14 71  
PL Nr: 099 120 102.3



**Stosstange klappbar 4x Lampenausschnitt**  
**Fahrzeugbreite 2500mm**

OE Vgl.-Nr: 628 880 13 71  
PL Nr: 099 120 102.2

## Ersatzteile für LKW und Bus



### MB Citaro Euro 2&3 Bodenkapselung

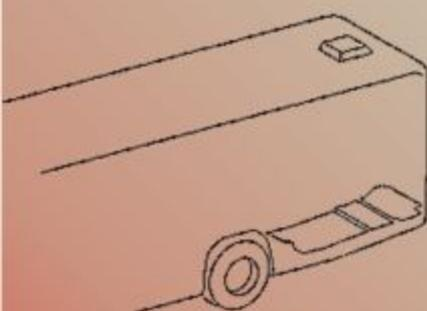

#### **Bodenkapsel Hinten Links**

OE Vgl.-Nr. 628 680 01 09  
PL Nr. 099 120 105



#### **Bodenkapsel Mitte Links**

OE Vgl.-Nr. 628 680 00 09  
PL Nr. 099 120 106



#### **Bodenkapsel Vorn Links**

OE Vgl.-Nr. 628 683 10 10  
PL Nr. 099 120 107



## Ersatzteile für LKW und Bus



## MB Citaro Euro 2&3 Bodenkapselung

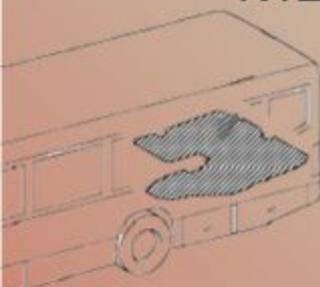

### Bodenkapsel Hinten Rechts

OE Vgl.-Nr. 628 683 27 08  
PL Nr. 099 120 064

### Bodenkapsel Vorn Rechts

OE Vgl.-Nr. 628 683 15 08  
PL Nr. 099 120 085

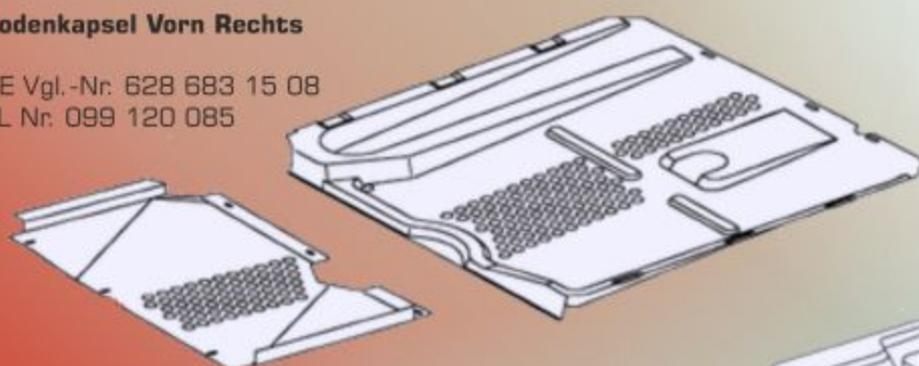

### Bodenkapsel Hinten Links

OE Vgl.-Nr. 628 683 05 08  
PL Nr. 099 120 035

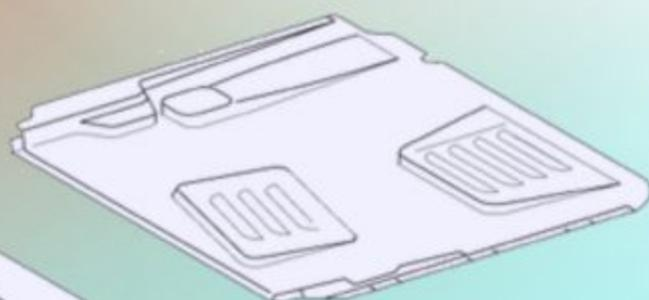

### Bodenkapsel Vorn Links

OE Vgl.-Nr. 628 683 02 08  
PL Nr. 099 120 037

### Bodenkapsel Vorn Links

OE Vgl.-Nr. 628 683 13 08  
PL Nr. 099 120 037.1

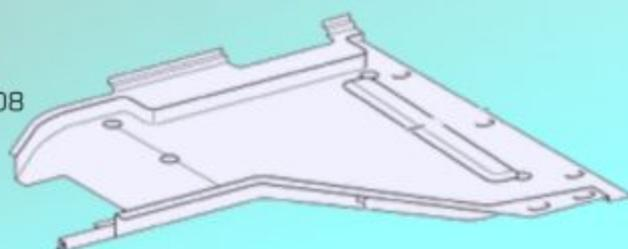

## Ersatzteile für LKW und Bus



### MB Citaro Euro 4 Front



**Stossecke Rechts (mit Nebelsw.)  
Facelift ab BJ. 2006**

OE Vgl.-Nr. 628 880 04 72  
PL Nr. 099 120 214

**Stossecke Links (mit Nebelsw.)  
Facelift ab BJ. 2006**

OE Vgl.-Nr. 628 880 03 72  
PL Nr. 099 120 202



**Stossecke Rechts (ohne Nebelsw.)  
Facelift ab BJ. 2006**

OE Vgl.-Nr. 628 880 02 72  
PL Nr. 099 120 215.1

**Stossecke Rechts (ohne Nebelsw.)  
Facelift ab BJ. 2006**

OE Vgl.-Nr. 628 880 01 72  
PL Nr. 099 120 203



**Frontklappe mit Emblemsicke  
Facelift ab BJ. 2006**

OE Vgl.-Nr. 628 885 05 26  
PL Nr. 099 120 211



**Frontspoiler unten  
Facelift ab BJ. 2006**

OE Vgl.-Nr. 628 885 04 01  
PL Nr. 099 120 200

## Ersatzteile für LKW und Bus



### MB Citaro Euro 4 Heck



**Stossecke Links**  
**Facelift ab BJ. 2006**

OE Vgl.-Nr. 628 885 00 05  
PL Nr. 099 120 205

**Stossecke Rechts**  
**Facelift ab BJ. 2006**

OE Vgl.-Nr. 628 885 01 05  
PL Nr. 099 120 207



**Stossecke Links (mit Nebelleuchte)**  
**Facelift ab BJ. 2006**

OE Vgl.-Nr. 628 885 06 05  
PL Nr. 099 120 204

**Stossecke Rechts (mit Nebelleuchte)**  
**Facelift ab BJ. 2006**

OE Vgl.-Nr. 628 885 05 05  
PL Nr. 099 120 208



**Stossfänger**

OE Vgl.-Nr. 628 880 47 71  
PL Nr. 099 120 210



**Abdeckkappe**

OE Vgl.-Nr. 628 885 06 22  
PL Nr. 099 120 210.1

## Ersatzteile für LKW und Bus



### MB Citaro Euro 3&4 Bodenkapselung

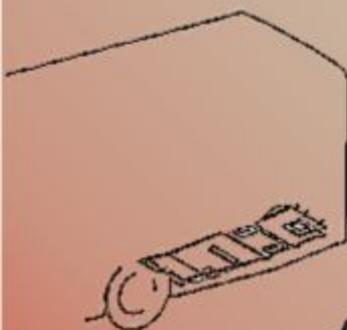

#### Bodenkapsel Hinten Links

OE Vgl.-Nr: 628 680 01 09  
PL Nr: 099 120 105

#### Bodenkapsel Mitte Links

OE Vgl.-Nr: 628 680 00 09  
PL Nr: 099 120 106



#### Bodenkapsel Vorn Links

OE Vgl.-Nr: 628 683 38 08  
PL Nr: 099 120 108

#### Bodenkapsel Hinten Mittig

OE Vgl.-Nr: 628 683 35 08  
PL Nr: 099 120 109

Profiline Import-Export GmbH

Buchhorsterstr. 23  
16567 Mühlenbeck / Germany

**PROFILINE**  
KLEEMANN SPARE PARTS

Tel: 049 33056/2873-11  
Fax: 049 33056/2873-21  
Mail: kleemann@profiline.com  
www.profiline.com

Ersatzteile für LKW und Bus



## MB Citaro Euro 4&5 Bodenkapselung



### Bodenkapsel Vorn Rechts

OE Vgl.-Nr. 628 683 15 08  
PL Nr. 099 120 085

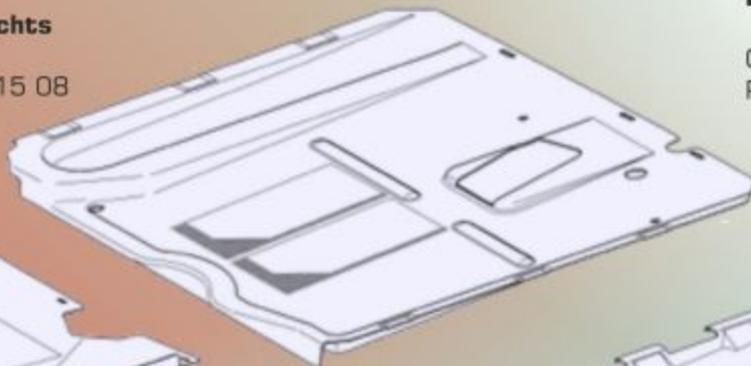

### Bodenkapsel Hinten Rechts

OE Vgl.-Nr. 628 683 45 08  
PL Nr. 099 120 043

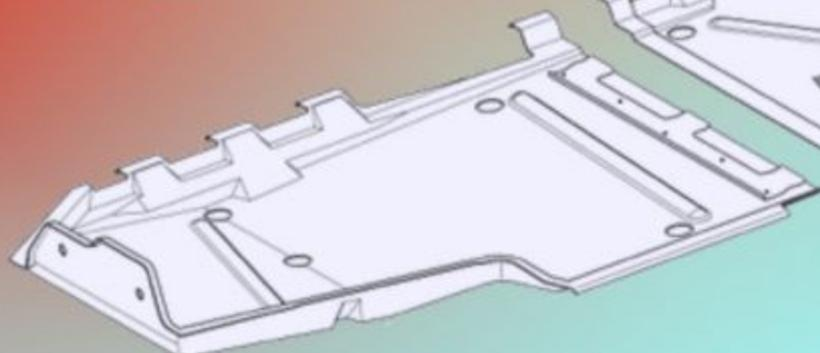

### Bodenkapsel Vorn Links

OE Vgl.-Nr. 628 683 40 08  
PL Nr. 099 120 021

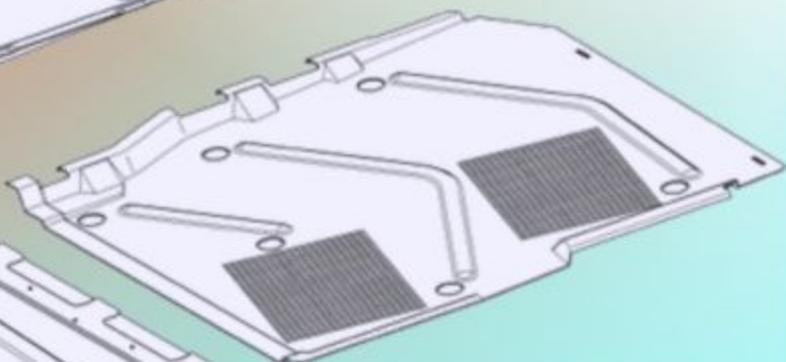

### Bodenkapsel Hinten Links

OE Vgl.-Nr. 628 683 23 08  
PL Nr. 099 120 022

+++ Angebot nur solange der Vorrat reicht +++ Angebot nur solange der Vorrat reicht +++

## Ersatzteile für LKW und Bus



### MB Citaro Euro 5 Heck



**Stossecke Links  
ohne Nebelschlussleuchte**

OE Vgl.-Nr. 628 885 22 05  
PL Nr. 099 120 091

**Stossecke Rechts  
ohne Nebelschlussleuchte**

OE Vgl.-Nr. 628 885 24 05  
PL Nr. 099 120 090



**Stossecke Links (mit Nebelleuchte)**

OE Vgl.-Nr. 628 885 20 05  
PL Nr. 099 120 091.1

**Stossecke Rechts (mit Nebelleuchte)**

OE Vgl.-Nr. Kundenwunsch  
PL Nr. 099 120 090.1



**Stossfänger**

OE Vgl.-Nr. 628 880 47 71  
PL Nr. 099 120 210



**Abdeckkappe**

OE Vgl.-Nr. 628 885 06 22  
PL Nr. 099 120 210.1

## Ersatzteile für LKW und Bus



### MB Citaro Euro 6 Heck

#### Stossecke Links ohne Nebelschlussleuchte

OE Vgl.-Nr. 628 885 30 05  
PL Nr. 099 120 139.1



#### Stossecke Rechts ohne Nebelschlussleuchte

OE Vgl.-Nr. 628 885 32 05  
PL Nr. 099 120 138.1



#### Bodenkapsel Hinten Links

OE Vgl.-Nr. 628 683 37 15  
PL Nr. 099 120 281

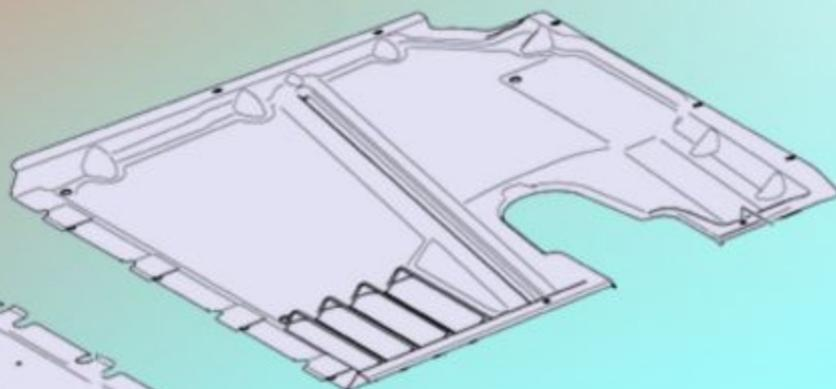

#### Bodenkapsel Vorn Links

OE Vgl.-Nr. 628 683 36 15  
PL Nr. 099 120 280

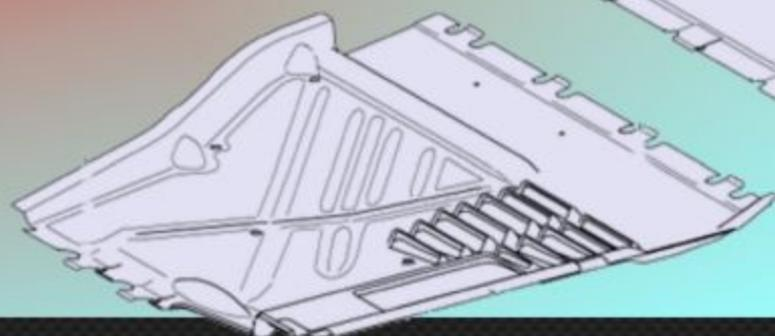

PL-number	pf./ applicable for	material	Dimension	picture
<b>086 000 004</b>				
Radkappe wheel cover	VA/ front axle Design Vinci1	metal CR-poliert CR-polished	22,5"	

PL-number	pf./ applicable for	material	Dimension	picture
<b>086 000 005</b>				
Radkappe wheel cover	HA/ rear axle Design Vinci1	metal CR-poliert CR-polished	22,5"	

PL-number	pf./ applicable for	material	Dimension	picture
<b>086 000 006</b>				
Halter Radkappen holder wheel cover	VA und HA Vinci1+2	plastic	all	

PL-number	pf./ applicable for	material	Dimension	picture
<b>086 000 006.1</b>				
Plastikkappe mitte plastiv cover	VA und HA Vinci1+2	plastic	all	

PL-number	pf./ applicable for	material	Dimension	picture
<b>086 000 007.1</b>				
6-Kant-Schlüssel tool for holder	Schlüssel zum Lösen und Befestigen der Radkappe tool for mounting wheel cover	metal/ plastic		

PL-number	pf./ applicable for	material	Dimension	picture
<b>086 000 016</b>				
Radkappe Classic wheel cover model classic	VA/ front axle	plastic flexibel	19,5"	

PL-number	pf./ applicable for	material	Dimension	picture
<b>086 000 017</b>				
Radkappen Classic wheel cover model classic	HA/ rear axle	plastic flexibel	19,5"	

PL-number	pf./ applicable for	material	Dimension	picture
<b>086 000 022</b>				
Radkappe wheel cover	VA/ front axle	metal CR-poliert CR-polished	17,5"	

PL-number	pf./ applicable for	material	Dimension	picture
<b>086 000 023</b>				
Radkappe wheel cover	HA/ rear axle	metal CR-poliert CR-polished	17,5"	

PL-number	pf./ applicable for	OE/ OEM-Ref.	Dimension	picture
<b>086 00 025</b>				
Radkappe Classic wheel cover model classic	VA/ front axle		17,5"	

PL-number	pf./ applicable for	material	Dimension	picture
<b>086 000 026</b>				
Radkappe Classic wheel cover model classic	HA/ rear axle	plastic flexibel	17,5"	

PL-number	pf./ applicable for	material	Dimension	picture
<b>086 000 027</b>				
Radkappe wheel cover	VA/ front axle	metal CR-poliert CD-polished	17,5"	

PL-number	pf./ applicable for	material	Dimension	picture
<b>086 000 028</b>				
Radkappe wheel cover	HA/ rear axle	metal CR-poliert CR-polished	17,5"	

PL-number	pf./ applicable for	material	Dimension	picture
<b>086 000 031</b>				
Radkappe Classic wheel cover model classic	VA/ front axle	plastic flexibel	22,5"	

PL-number	pf./ applicable for	material	Dimension	picture
<b>086 000 032</b>				
Radkappe Classic wheel cover model classic	HA/ rear axle	plastic flexibel	22,5"	

PL-number	pf./ applicable for	material	Dimension	picture
<b>086 000 043</b>				
Radkappe wheel cover	VA/ front axle HA/ rear axle	plastic weiß white	22,5"	

PL-number	pf./ applicable for	material	Dimension	picture
<b>086 000 044</b>				
Radkappe wheel cover	VA/ front axle HA/ rear axle	plastic silber silver	22,5"	

PL-number	pf./ applicable for	material	Dimension	picture
<b>086 000 045</b>				
Radkappe wheel cover	VA/ front axle	plastic weiß white	22,5"	

PL-number	pf./ applicable for	material	Dimension	picture
<b>086 000 046</b>				
Radkappe wheel cover	HA/ rear axle	plastic weiß white	22,5"	

PL-number	pf./ applicable for	material	Dimension	picture
<b>086 000 045.2</b>				
Radkappe wheel cover	VA/ front axle	plastic weiß white	17,5"	

PL-number	pf./ applicable for	material	Dimension	picture
<b>086 000 046.2</b>				
Radkappe wheel cover	HA/ rear axle	plastic weiß white	17,5"	

PL-number	pf./ applicable for	material	Dimension	picture
<b>086 000 047</b>				
Radkappe wheel cover	Setra 500er Serie VA/ front axle HA/ rear axle	plastic weiß white	22,5"	

PL-number	pf./ applicable for	material	Dimension	picture
<b>086 000 058</b>				
Radkappe wheel cover	MB Sprinter VA/ front axle	metal CR-poliert CR-polished	16"	

PL-number	pf./ applicable for	material	Dimension	picture
<b>086 000 059</b>				
Radkappe wheel cover	MB Sprinter bei Doppelbereifung HA/ rear axle by double wheel	metal CR-poliert CR-polished	16"	

PL-number	pf./ applicable for	material	Dimension	picture
086 110 003				
Radmutterabdeckung wheel bold cover	VA/ front axle	metal NC Nickel-Crom	22"	

PL-number	pf./ applicable for	material	Dimension	picture
086 110 004				
Radmutterabdeckung wheel bold cover	VA/ front axle	metal V2A Edelstahl	22"	

PL-number	pf./ applicable for	material	Dimension	picture

PL-number	pf./ applicable for	material	Dimension	picture

PL-number	pf./ applicable for	material	Dimension	picture

PL-number	pf./ applicable for	material	Dimension	picture

## QUALITY AND WARRENTY CERTIFICATE !!!

our terms of business are defined in our homepage [www.profiline.com](http://www.profiline.com)

The owner of the brand "Profiline Kleemann" assures failsafe operation, long service life of all "Profiline Kleemann" spare parts.

From the initial sample up the final product all quality criterias will be considered, regular inspections and random functionality tests of our products as well as a professional warehousing ensure that only parts of best quality leave the warehouse.

Insofar as nothing to the contrary is expressly agreed to, the owner of "Profiline Kleemann" provides a warranty for freedom from defects of the delivered parts for a duration of 12 months, commencing date = date of invoice. In case a material or manufacturing defect should occur we will replace the defective "Profiline Kleemann" product free of charge at anytime during the warranty period, an possible defect has to report to the owner of the brand "Profiline Kleemann" right after arise.

As far as repairs are possible the right to replace the defective parts is waived. Under certain circumstances the owner of "Profiline Kleemann" may offer his assistance for labour reimbursement when due to the failure of a "Profiline Kleemann" part collateral damages occur.

These cases will be handled on a case by case basis only and should be notified in writing withim a period of 1 month.

The conditions of this warranty become invalid if the parts delivered is modified, unless the defect has no causal can use with the modification.

"Profiline Kleemann" products have to be mounted by qualified personel only, the instructions of the vehicle manufacturers have to be followed. Moreover this guarantee excludes wear and tear damages, caused by improper usage.

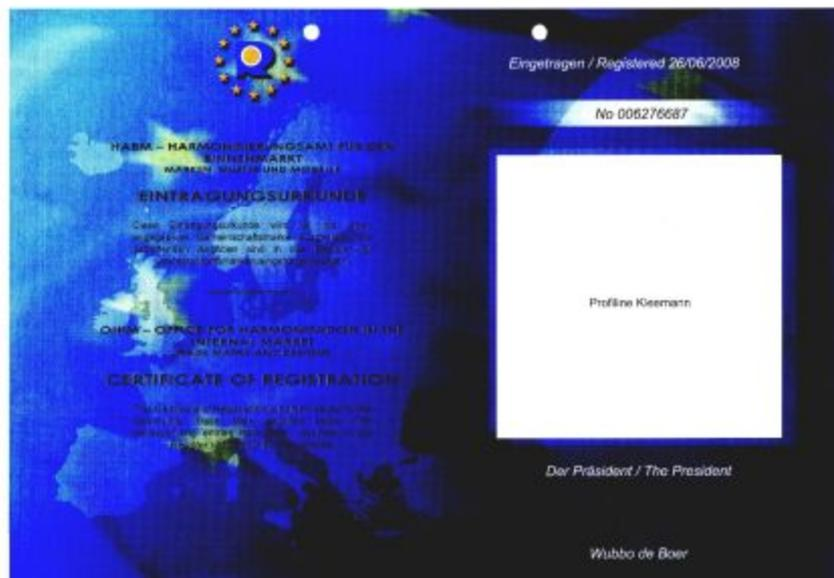

**CHEAP**

**FAST**

**RELIABLE**



**TWENTY YEARS EXPERIENCE  
IN THE AREA OF  
BUS AND TRUCK PARTS**

Version 03-2017

PROFILINE DELIVERY SPARE PARTS WORLDWIDE