

PROFILINE

KLEEMANN SPARE PARTS

Germany



German quality repair and accessories parts

BUS SPECIAL EQUIPMENT

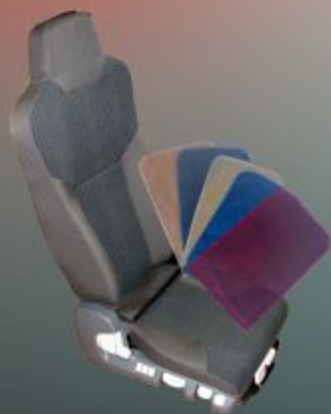

www.profiline.com

So erreichen Sie uns/ contact to us

Verkauf/ Sales

phone: +49 33056/ 2873 -10/ -11

telefax: +49 33056/ 2873-33

mail: sales@profiline.com

Gewährleistungen/ Warrenty

phone: +49 33056/ 2873 -11

telefax: +49 33056/ 2873-33

Buchhaltung/ Accounting

phone: +49 33056/ 2873 -38

telefax: +49 33056/ 2873-39

mail: accounting@profiline.com

Lager-Versand/ Storekeeper

phone: +49 33056/ 2873 -58/ -59

telefax: +49 33056/ 2873-44

Geschäftsleitung/ Management

phone: +49 33056/ 2873 -27/ -10

telefax: +49 33056/ 2873-21

mail: kleemann@profiline.com

Das PROFILINE-Team

Service steht für uns an erster Stelle.

Damit unsere Ersatzteile schnell bei Ihnen sind, achten wir auf eine hohe Verfügbarkeit und stehen Ihnen mit einem zuverlässigen Lieferservice zur Seite-weltweit.

Wir freuen uns auf eine erfolgreiche Zusammenarbeit mit Ihnen.

The PROFILINE-Team

Service is our number one priority.

So that our replacement parts are fast to you, we pay attention to high availability and are available world-wide with a reliable delivery service.

We look forward to a successful cooperation with you.

Dear customer,

thank you for your interest in our products.

This catalogue includes a well considered spare-part-assortment of high class articles.

Herewith you gain purchase-informations of PROFILINE Import-Export GmbH.

Dear customer,

PROFILINE brand spare parts are no original parts of any vehicle-maker.

PROFILINE is registered and trademarked.

Important Notes

All stated informations are based on available documentations.

Liabilities cannot be assumed for any errors or omissions.

All informations are subject to technical changes. Part numbers, descriptions or manufactures are for comparison purposes only. They are no indication of origin parts and should not be used to endconsumers. Any claims based on given catalogue-datas will not be admitted.

Reprints, reproductions also in extracts require written permission.

How do I become a PROFILINE customer ?

Just complete our FORM and return same to us.

If requested the FORM will be submitted.

Offers

We offer spare parts at best possible terms and at rock-bottom prices.

Therefore extra discounts or bonus agreements or other allowances cannot be granted additionally.

Deliveries

All prices to be understood EX WAREHOUSE Mühlenbeck.

If assistance is required we can deliver ordered spare parts at low transportation costs to you. Following alternatives can be offered:

National Parcel Service (48 hours service)

International Parcel Service (delivery-time dependent on the country)

National Overnight Service (delivery next working day at 9 AM, a respective locker-facility is required)

National Daytime Service (delivery next working day between 8.00 to 12.00 AM)

Ordinary national or international deliveries by truck, ship or aircraft

Service

Service for us ranks first.

For this reason we pay attention to a high availability rate of our spare part offer and assure our customers professional support.

Imprint

Profiline Import-Export GmbH, Buchhorster Str. 23, D-16567 Mühlenbeck, Germany

Tel: +49 33056 2873-10 / -11, FAX: +49 33056 2873-33 E-Mail: kleemann@profiline.com

Internet: www.profiline.info

Register of companies: Amtsgericht Neuruppin HRB9256NP

VAT-Reg. No: DE 173223636 / TAX-Number: 053/116/02359

Bank: Berliner Sparkasse BLZ: 10050000 Account No.: 630033099

BIC: BELADEBEXXX

IBAN: DE 16 1005 0000 0630033099

manager: Andreas Kleemann

Informationen zu Verkauf, Versand, Service sowie Impressum

Sehr geehrte Kundschaft,

dieser Katalog beinhaltet ein ausgereiftes Produktsortiment von höchster Qualität. Sie erhalten hiermit Einkaufsinformationen über die von der Profiline Import-Export GmbH angebotenen Ersatzteile. Profiline Ersatzteile sind keine Originalteile des Fahrzeugherstellers. Profiline ist eine geschützte und eingetragene Marke und bürgt für höchste Qualität und Austauschbarkeit.

Wichtige Hinweise,

die in diesem Katalog enthaltenen Informationen sind auf Grund verfügbarer Dokumentationen und Informationen sorgfältig erstellt worden. Für eventuelle Fehler oder Auslassungen kann jedoch keinerlei Haftung übernommen werden. Technische Änderungen bleiben vorbehalten.

In diesem Katalog sind sämtliche Namen, Nummern und Beschreibungen von Fahrzeugteilen oder Herstellern u.ä. nur zu Vergleichszwecken aufgeführt. Sie sind keine Herkunftsbezeichnung und dürfen Fahrzeugbesitzern gegenüber nicht verwendet werden.

Die Original- Ersatzteile-Nummern der Fahrzeug- und Motorenhersteller dienen nur internen Vergleichszwecken. Informationen über eventuelle Fehler im Katalog sind uns willkommen und werden in den zukünftigen Ausgaben korrigiert.

Alle Angaben sind sorgfältig bearbeitet, aber unverbindlich. Ersatzansprüche aufgrund dieser Angaben können nicht anerkannt werden. Nachdruck, Nachahmung und Vervielfältigung, auch auszugsweise, ist nur mit schriftlicher Genehmigung und mit Quellenangabe gestattet.

Wie werde ich Kunde ?

Kein Problem, füllen Sie unser Neukundeninfoblatt aus und schicken Sie dies an uns zurück. Das Neukundeninfoblatt schicken wir Ihnen gern per Mail oder Fax.

Extras für Wiederverkäufer,

wir bieten Ihnen die Ersatzteile zu bestmöglichen Konditionen an, das heißt, zu von uns knapp kalkulierten Nettopreisen. Wir geben Ihnen einen Top-Preis. Weitere Rabatte, Mengenrabatte, Jahresbonusverträge oder Ähnliches können wir auf dieser Preisebene nicht mehr gewähren.

Transport und Anlieferung von Waren,

alle Preise gelten frei Lager Mühlenbeck. Wir haben aber die Möglichkeit, Ihnen zu ausgehandelten Top-Tarifen die Ware über mehrere Transportwege zuzustellen.

Es bestehen folgende Möglichkeiten:

National Paketdienst (48h)

International Paketdienst (abhängig vom Land)

National Nachtexpress (bis 9.00 Uhr nächster Werktag bei Ihnen, Voraussetzung ist ein verschließbares Depot)

National Tagexpress (Anlieferung nächster Werktag zwischen 8.00 - 12.00 Uhr gegen Unterschrift)

National und International - Speditionszustellung mit LKW

International - Luftfracht ab Flughafen Tegel

Service,

steht für uns an erster Stelle.

Damit unsere Ersatzteile schnell bei Ihnen sind, achten wir auf eine hohe Verfügbarkeit und stehen Ihnen mit einem zuverlässigen Lieferservice zur Seite - weltweit.

Ich freue mich auf eine erfolgreiche Zusammenarbeit mit Ihnen.

Impressum,

Profiline Import-Export GmbH, Buchhorster Str. 23, 16567 Mühlenbeck

Tel: +49 33056 2873-10/-11 FAX: +49 33056/2873-33 E-Mail: kleemann@profiline.com

Internet: www.profiline.com

Handelsregister: Amtsgericht Neuruppin HRB9256NP









UST-ID: DE 173223636/ Steuernummer: 053/116/02359





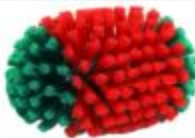

Bank: Berliner Sparkasse BLZ: 10050000 Konto-Nr.: 0630033099

BIC: BELADEBEXXX

IBAN: DE 16 1005 0000 0630033099

Geschäftsführer: Andres Kleemann

PL-number	Dimension	picture
027 000 040		
Waschbürste schmal wash brush small	270mm	
027 000 088		
Waschbürste breit wash Brush wide	400mm	
027 002 007		
Teleskopstiel telescopic handle	1650mm 3000mm	
027 002 007.1		
Adapter Schlauchanschluß für Teleskopstiel		
027 002 007.2		
Adapter zu Gardena für Teleskopstiel		
027 000 091		
Felgenbürste rim brush	140x200mm	
027 004 000		
Flächentrockner surface dryer	350mm	
027 004 001	450mm	
027 003 000		
Fensterwischer window wiper	400mm	
071 805 005		
Stiel Fensterwischer handle window wiper	1200mm	

PL-number	technical specification	picture
028 010 030		
Reiseleitermikrofon-Set Mikrofon mit Spiralkabel Tour guide Microfone Set	Dynamic Rubber Microphone Microphone Length: 152,1mm Coil Cable Length: 1020mm Transducer Type: Dynamic	
028 010 030.1		
Spiralkabel einzeln pf.Reiseleitermifrofon cable only for Tour guide Microfone	Coil Cable Length: 1020mm	
028 010 031		
Reiseleitermikrofon Tour guide Microfone	Element: Dynamic Polar Pattern: Uni-directional Output Impedance: 600Ohm Sensitivity: -65dB	
028 010 032		
Schwanenhalsmikrofon Gooseneck Driver Microphone	gooseneck rubber microphone Length: 670mm Color: black Transducer Type: Dynamic Frequency Response:: 100Hz-13KHz Output Impedance: 200Ohm	
028 010 032.1		
Mikronkopf einzeln pf.Schwanenhalsmikrofon Microfon only for Gossneck Driver Microphone	Color: black Transducer Type: Dynamic Frequency Response:: 100Hz-13KHz Output Impedance: 200Ohm	
028 010 032.2		
Schaumstoff-Schutzkappe Foam protection cap		

PL-number	technical specification	picture
028 010 033		
Funkmikrofon-Set mit 2x Mikrofon und Ladestation Wireless Chargable Microphone Set (two Microphones)	Receiver: working voltage: DC18-36V Dynamic range: >90dB Frequency 2CH handheld transmitter: Carrier frequency range: UHF 790- 810Mhz Power supply: 2x1,5V AA No.3 battery	

PL-number	technical specification	picture
028 010 040		
Busradio MP3 Radio-Player	working voltage: DC12-24V Dimension: 182x52x168 function: play MP3 audio files/ AM- FM/ Mic storage medium: U disk/ SD card media files supporting: mp3 Certification: E-mark/ UL94VO	

PL-number	technical specification	picture
028 010 050		
Videoplayer Vehicle-mounted Dual Zone Full HD player	working voltage: DC12 Dimension: 182x52x176 Play Mode: inside high capacity hard disk Support media file: mov/ mkv avi/ vob/ mpg/ dat/ mp4/ m4v/ rm/ ts mp3/ wma/ wav/ m4a/ flac/ jpg/ bmp png/ gif starge medium: SD card U disc internal or external hard-disc Certification: E-mark/ UL94VO	

PL-number	technical specification	picture

PL-number	technical specification	picture

PL-number	technical specification	picture
028 010 000		
19" LED Busmonitor (Festanbau) 19" LED Wide-Screen Fixed Monitor	working voltage: DC12-24V Resolution: 1440x900 Dimension: 474x320x62 Image format = 16:9 Video format: Pal/ NTSC (Self-Adaption) Installation: top mounting hanging/ hoop Certification: E-mark/ UL94VO	

PL-number	technical specification	picture
028 010 001		
19" LED Busmonitor (elektrisch klappbar) Monitor 19" LED Wide-Screen Motorized Flip-Down	working voltage: 24V Resolution: 1440x900 Dimension: 556x319x83 Image format = 16:9 Video format: Pal/ NTSC (Self-Adaption) Installation: to mounting Certification: E-mark/ UL94VO	

PL-number	technical specification	picture
028 010 011		
18,5" LED Busmonitor (elektrisch klappbar) Monitor 18,5" LED Wide-Screen Motorized Flip-Down	working voltage: 24V Resolution: 1280x1024 Dimension: 486x371x82 Image format = 4:3 Video format: Pal/ NTSC (Self-Adaption) Installation: to mounting Certification: E-mark/ UL94VO	

PL-number	technical specification	picture
028 010 021		
24V/ 15" 1024x768 LCD Busmonitor (elektrisch klappbar) Monitor 15" LCD Wide-Screen Motorized Flip-Down	working voltage: 24V Resolution: 1024x768 Dimension: 454x299x69 Image format = 4:3 Video format: Pal/ NTSC (Self-Adaption) Installation: to mounting Certification: E-mark/ UL94VO	

PL-number	technical specification	picture

PL-number	pf./ applicable for	picture
028 103 000		
Auslegware carpeting	Synthetik-Auslegware "Rips" Rolle/ role = 25m ² Materialstärke = 10mm thickness = 10mm Rollenbreite/ width = 2000mm	

PL-number	pf./ applicable for	picture
028 112 110		
Becherhalter cup holders	schwarz/ black (D=70)	

PL-number	pf./ applicable for	picture
028 112 104		
Becherhaltercup holders	zum Einlassen in Holztische (72x35)	

PL-number	Dimension	picture
028 112 004		
Klapptisch tabel	325x180	

PL-number	pf./ applicable for	picture
028 112 017	OE-Ref.	
Klapptisch tabel	Klapptisch ohne Cupholder Evo grau Setra 400er Serie (406/385x190x20) 629 810 01 66	

PL-number	pf./ applicable for	picture
028 111 207	Dimension	
Rückenlehnnetz rack	Rückenlehnnetz mit Kunststoffrahmen und schmalen Gummirand (360x180)	

PL-number	pf./ applicable for	OE/ OEM-Ref.	picture
028 000 095			
Wasserpumpe water pump	Wasserpumpe für Trinkwasseranlagen und Toilettenspülung Water pump for drinking water and toilet flushing	8.754.431.000 1103 945 3 N1.011003-9453 1552.771.00 1552.772.00	

PL-number	pf./ applicable for	OE/ OEM-Ref.	picture
028 000 096			
Wasserpumpe water pump	Schmutzwasserpumpe pumpt fäkalienhaltiges Wasser Dirty water pump pumps sewage containing water	000 860 38 26 36.77630.6059 1103 990 5 1502.620.000	

PL-number	pf./ applicable for	OE/ OEM-Ref.	picture
028 000 096.1			
Reparatursatz repair-set	Impeller für 028 000 096	000 986 09 00	



PL-number	pf./ applicable for	OE/ OEM-Ref.	picture
028 007 703			
Filter	Wasser-Filter 1/2"-12mm Einbau vor Pumpe	1103 990 3 2002 089 60	



PL-number	pf./ applicable for	OE/ OEM-Ref.	picture
028 007 707			
Filter	Shurflo-Pumpe 028 000 096 mit Innengewinde und Schlauchanschluß 10-12mm		



PL-number	pf./ applicable for	OE/ OEM-Ref.	picture
028 007 708			
Filter	Shurflo-Pumpe 028 000 096 mit Innen- und Außengewinde		

PL-number	pf./ applicable for	OE/ OEM-Ref.	picture
028 007 800			
Wassertank water tank	für Frischwasser for drinking water	8.754.490.00	

PL-number	pf./ applicable for	picture
028 200 060		
Toilettenschieber toilet slide	unterer Schieber ohne Drosselventil lower toilet slide without valve	
028 200 061		
Toilettenschieber toilet slide	oberer Schieber mit Drosselventil top toilet slide with valve	
028 200 063		
Anschlußflansch flange	028 200 060-061	Schlauchanschluß 3" Innengewinde 
028 200 064		
Anschlußflansch flange	028 200 060-061	Schlauchanschluß 
028 200 065		
Dichtung gasket	028 200 060-061	
028 200 003		
Toilettenschieber toilet slide	Thetford	

PL-number	picture	Description
028 200 035 1L Flasche 1L bottle		<p>Desinfizierendes, hochwirksames Sanitärkonzentrat für alle Frischwasser-, Spül- und Chemietoiletten. Profiline Bio-Clean verhindert Gasbildung, wirkt keimabtötend, vernichtet Bakterien, Viren und Pilze ! Disinfectant highly effective sanitary concentrate for all fresh water, irrigation and chemical toilets. Profiline Bio-Clean prevents gas formation and germicidal effect, destroys bacteria, viruses and fungi</p>
		





PL-number	picture	Description
028 200 036 5L Flasche 5L bottle		<p>Desinfizierendes, hochwirksames Sanitärkonzentrat für alle Frischwasser-, Spül- und Chemietoiletten. Profiline Bio-Clean verhindert Gasbildung, wirkt keimabtötend, vernichtet Bakterien, Viren und Pilze ! Disinfectant highly effective sanitary concentrate for all fresh water, irrigation and chemical toilets. Profiline Bio-Clean prevents gas formation and germicidal effect, destroys bacteria, viruses and fungi</p>
		

PL-number	picture	Description
028 200 037 25L Flasche 25L bottle		<p>Desinfizierendes, hochwirksames Sanitärkonzentrat für alle Frischwasser-, Spül- und Chemietoiletten. Profiline Bio-Clean verhindert Gasbildung, wirkt keimabtötend, vernichtet Bakterien, Viren und Pilze ! Disinfectant highly effective sanitary concentrate for all fresh water, irrigation and chemical toilets. Profiline Bio-Clean prevents gas formation and germicidal effect, destroys bacteria, viruses and fungi</p>
		

PL-number	picture	Description

PL-number	picture	Description

PL-number	picture	Description

PL-number	pf./ applicable for	picture
028 706 062PL		
Nothammer emergency hammer	mit geschlossenem Handgriff	
028 706 064PL		
Nothammer emergency hammer	mit geschlossenem Handgriff, mit Diebstahlsicherung und akustischen Alarm with theft and audible alarm	
028 706 062PL1		
Nothammer emergency hammer	mit geschlossenem Handgriff	
028 706 060		
Nothammer emergency hammer	mit offenem Handgriff	
028 706 065		
Nothammer emergency hammer	mit geschlossenem Handgriff und Gurtschneider	
PL-number	pf./ applicable for	picture

PL-number

059 000 100

mechanischer Fahrersitz

mechanical suspended driver-seat

- >Bedienelemente links/ left control
- >Kopfstütze/ headrest
- >2x Armlehnen/ two armrest
- >zwei Punkt Gurt/ 2-point safety belt
- >Rückenlehnenverstellung/ back rest adjustment
- >Höhenlehneneinstellung/ highs and lows adjustment
- >Neigungseinstellung/ down-grade adjustment
- >Spurbreite=216mm/ track width=216mm

solide - robust - preiswert

strong, robust, easy to handle and worth the money

picture



PL-number

059 000 101

luftgefederter Fahrersitz

air suspended driver-seat

- >Bedienelemente links/ left control
- >Kopfstütze/ headrest
- >2x Armlehnen/ two armrest
- >zwei Punkt Gurt/ 2-point safety belt
- >Rückenlehnenverstellung/ back rest adjustment
- >Höhenlehneneinstellung/ highs and lows adjustment
- >Neigungseinstellung/ down-grade adjustment
- >Spurbreite=216mm/ track width=216mm

solide - robust - preiswert

strong, robust, easy to handle and worth the money

picture



PL-number

059 000 102

luftgefederter Fahrersitz

air suspended driver-seat

- >Bedienelemente links/ left control
- >Kopfstütze/ headrest
- >2x Armlehnen/ two armrest
- >drei Punkt Gurt/ 3-point safety belt
- >Rückenlehnenverstellung/ back rest adjustment
- >Höhenlehneneinstellung/ highs and lows adjustment
- >Neigungseinstellung/ down-grade adjustment
- >Spurbreite=216mm/ track width=216mm

solide - robust - preiswert

strong, robust, easy to handle and worth the money

picture



Fahrersitz mechanisch gefedert



- Spurbreite 230mm
- Neigungsverstellung
- Rückenlehnenverstellung
- Höhenverstellung 40-130KG
- 2 Punktgurt

PROFILINE NR. 059 000 103

SITTING SCISSORS UP

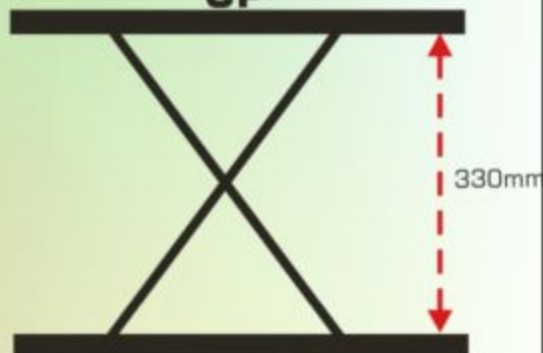

DOWN

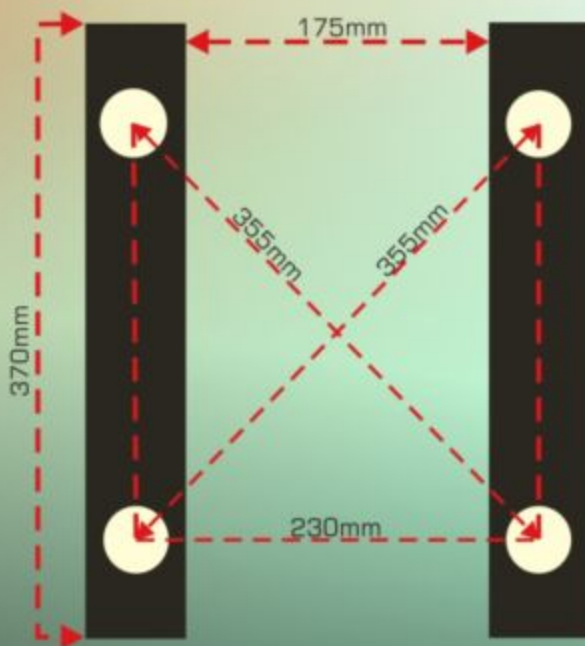
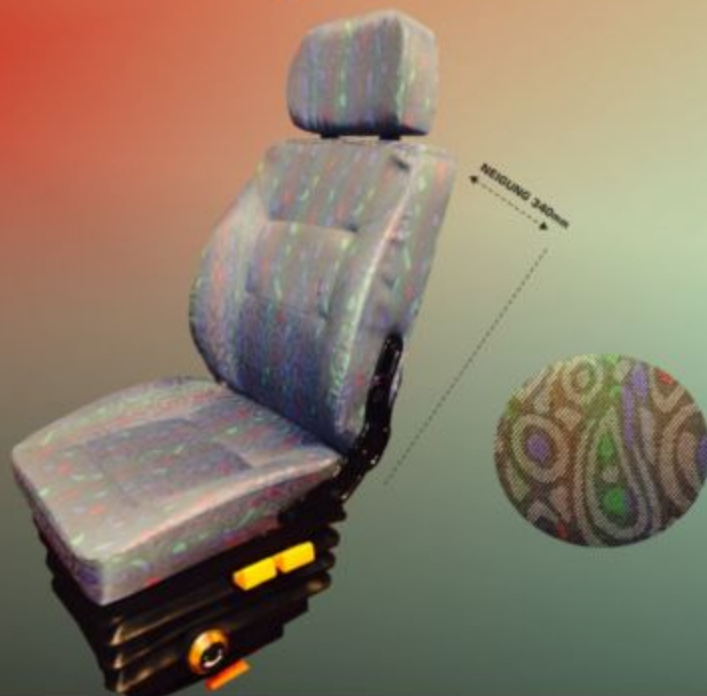

PROFILINE

KLEEMANN SPARE PARTS

Germany

Fahrersitz luftgefedert

SITTING SCISSORS



- Spurbreite 230mm
- Neigungsverstellung
- Rückenlehnenverstellung
- Höhenverstellung
- 2 Punktgurt

PROFILINE NR. 059 000 104

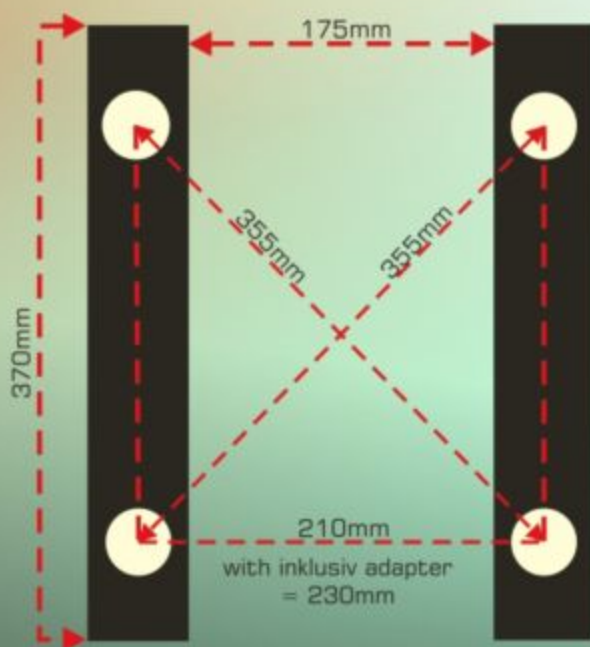
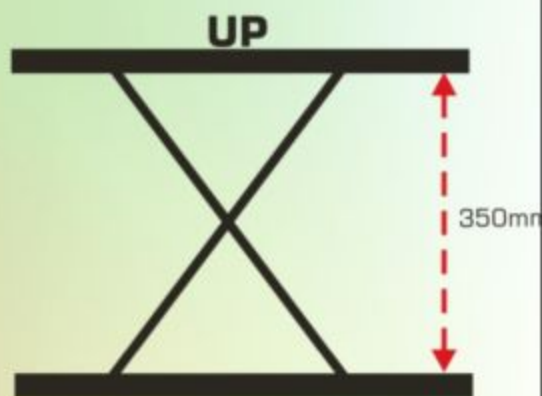

www.profiline.com

Luftgefederter Fahrersitz

- Bedienelemente Hebel links
- inclusive Kopfstütze
- Automatische Gewichtseinstellung bis 130kg
- Sitzneigungseinstellung
- Längsverstellung
- Rückenlehneneinstellung
- Sitzkissentiefeinstellung

solide und robust
preiswert und funktionell

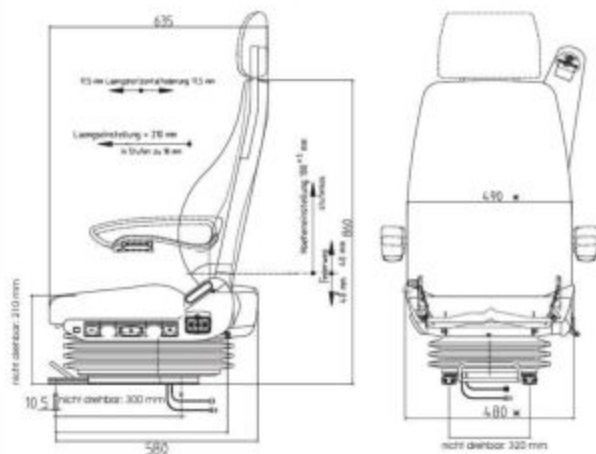

Fahrersitz Grammer luftgefedert	
Artikel-Nr.	Ausstattung
059 400 300	Grundmodell Luftsitz
059 400 300-3PG-2AL	2xArmlehnen / 1xBeckengurt
059 400 300-3PG-2AL.1	2xArmlehnen / 1xBeckengurt Heizung / Lendenwirbelstütze
059 400 300-3PG-2AL.2	2xArmlehnen / 1xBeckengurt Heizung / Lendenwirbelstütze automatisch einrastende Wippf.



AGR: 059 100 - Kopfschonbezüge/ Head-Slip-Covers

Kopfschonbezüge für Omnibussitze moderne Variante als Latz zum darüberlegen in Samt



Profiline-number	Bezeichnung/ Description
	Kopflätze aus Samt mit Klettband (männlich)
	Head flaps of velvet with hook and loop fastener (masculine)
	Farbscala/ Survey colors
059 100 207PL	Farbe1: hellgrün/ light green
059 100 206PL	Farbe2: grün/ green
059 100 215PL	Farbe3: dunkelgrün/ darkgreen
059 100 216PL	Farbe4: türkis/ turquois
059 100 213PL	Farbe5: gelb/ yellow
059 100 214PL	Farbe6: beige/ beige
059 100 217PL	Farbe7: braun/ brown
059 100 210PL	Farbe8: rot/ red
059 100 211PL	Farbe9: lachs/ salmon
059 100 208PL	Farbe10: violett-lila/ violet purple
059 100 221PL	Farbe11: dunkelmarineblau/ darkmarineblue
059 100 218PL	Farbe12: marineblau/ marineblue
059 100 205PL	Farbe13: blau/ blue
059 100 219PL	Farbe14: babyblau/ baby blue
059 100 220PL	Farbe15: hellblau/ light blue
059 100 222PL	Farbe16: eisblau/ ice blue
059 100 201PL	Farbe17: hellgrau/ light grey
059 100 202PL	Farbe18: grau/ grey
059 100 203PL	Farbe19: dunkelgrau/ dark grey
059 100 200PL	Farbe20: anthrazit/ anthrazit
059 100 212PL	Farbe21: aubergine/ aubergine
059 100 204PL	Farbe22: schwarz/ black



Profiline-number	Bezeichnung/ Description
059 100 028	Klettband 1xRolle



PL-number	pf./ applicable for	Dimension	picture
059 101 003 PLEX			
Gurt Lap belts	Automatik Beckengurt für Fahrgaststize mit flexibler Gurtpeitsche automatic lap belt	Gurtschloß L=270	

PL-number	pf./ applicable for	Dimension	picture
059 101 003			
Gurt Lap belts	Automatik Beckengurt für Fahrgaststize mit flexibler Gurtpeitsche automatic lap belt	Gurtschloß L=220	

PL-number	pf./ applicable for	Dimension	picture
059 101 004			
Gurt Lap belts	Automatik Beckengurt für Fahrgaststize mit starrer Gurtpeitsche automatic lap belt	Gurtschloß L=150 M10	

PL-number	pf./ applicable for	Dimension	picture
059 101 004.2			
Gurt Lap belts	Automatik Beckengurt für Fahrgaststize mit flexible Gurtpeitsche automatic lap belt	Gurtschloß L=120 M10	

PL-number	pf./ applicable for	Dimension	picture
059 101 004.4			
Gurt Lap belts	Automatik Beckengurt für Fahrgaststize mit flexible Gurtpeitsche automatic lap belt	Gurtschloß L=90 M10	

PL-number	pf./ applicable for	Dimension	picture

PL-number	pf./ applicable for	Dimension	picture
059 101 003.1			
Gurt Lap belts	Statik Beckengurt für Fahrgaststze mit flexibler Gurtpeitsche	Gurtschloß L=195	
059 101 003.2			
Gurt Lap belts	Statik Beckengurt für Fahrgaststze mit flexibler Gurtpeitsche	Gurtschloß L=300	
059 101 003.3			
Gurt Lap belts	Statik Beckengurt für Fahrgaststze mit flexibler Gurtpeitsche	Gurtschloß L=600	
059 101 003.4			
Gurt Lap belts	Statik Beckengurt für Fahrgaststze mit flexibler Gurtpeitsche	Gurtschloß L=450	
059 101 004.1			
Gurt Lap belts	Statik Beckengurt für Fahrgaststze mit starrer Gurtpeitsche	Gurtschloß L=97	
059 101 004.3			
Gurt Lap belts	Statik Beckengurt für Fahrgaststze mit starrer Gurtpeitsche	Gurtschloß L=150	
059 101 005			
Gurt Lap belts	Statik Beckengurt für Fahrgaststze mit starrer Gurtpeitsche	Gurtschloß L=150	

PL-number	pf./ applicable for	OE/ OEM-Ref.	Dimension	picture
059 999 000				
Sitzdämpfer seat dampers	Grammer Fahrgastsitz MAN LionsClassic	83.78611.6001 83.78110.0500	500N	
059 999 001				
Sitzdämpfer seat dampers	Fahrsitz Isringhausen 6500/517 MAN LionsCity Neoplan N4516-20-21-22	81.62385.6041	L1=168 L2=220 M12	
059 999 002				
Sitzdämpfer seat dampers	Fahrgastsitz Vogel bis Baujahr 94 MAN 292-332-362-A32	81.78334.0097 88.78334.6001 1104 847 2 N1.01104-8476	N=600	
059 999 003				
Sitzdämpfer seat dampers	Fahrgastsitz Vogel ab Baujahr 95 MAN LionsRegio LionsCoach/ LionsCity	81.78334.0120 1104 847 8 N1.01104-8478 N1.01104.8549	N=700 L=102	
059 999 004				
Sitzdämpfer seat dampers	Fahrgastsitz Kiel MAN LionsCity LionsCoach/ LionsStar Bova Futura Neoplan N2216	81.78611.0002 81.78434.0184 83.62941.6502	N=550	
059 999 005				
Sitzdämpfer seat dampers	Fahrgastsitz MB O550 Integro	8.811.000.026	N=500 L1=163	
059 999 006				
Sitzdämpfer seat dampers	Fahrgastsitz MB	000 959 16 85	N=500 L1=210 L2=236	
059 999 007				
Sitzdämpfer seat dampers	Fahrgastsitz MB O580 Travego	629 959 00 85	N=500 L1=177 L2=216	

PL-number	pf./ applicable for	OE/ OEM-Ref.	Dimension	picture
059 999 009				
Sitzdämpfer seat dampers	Fahrgastsitz MB O350-550-580 (Euro6) S415-416 H-HD S415-416GT/ S431DT S415-416-417HDH S412-415-416-416-419UL 511HD/ S515-517-519HDH S515-517-519MD	629 970 00 64	N=450 M10 M8	

PL-number	pf./ applicable for	OE/ OEM-Ref.	Dimension	picture
059 999 010				
Sitzdämpfer seat dampers	Fahrgastsitz VanHool	660173209	N=150 L=248	

PL-number	pf./ applicable for	OE/ OEM-Ref.	Dimension	picture
059 999 011				
Sitzdämpfer seat dampers	Fahrgastsitz MB O350 Tourismo	629 959 01 95		





PL-number	pf./ applicable for	OE/ OEM-Ref.	Dimension	picture
059 999 012				
Sitzdämpfer seat dampers	Fahrgastsitz Scania Irizar		N=500 L=170	

PL-number	pf./ applicable for	OE/ OEM-Ref.	Dimension	picture
059 999 013				
Sitzdämpfer seat dampers	Fahrgastsitz Bova Sitzgestell		N=850	

PL-number	pf./ applicable for	OE/ OEM-Ref.	Dimension	picture
059 999 015				
Sitzdämpfer seat dampers	Fahrgastsitz Kiel Avance MAN LionsCoach LionsStar/ LionsRegio N1216-17-18/ N2216/ N2216-3 N3516/ N3516-3/ N1122-3	36.97006.0002 81.97006.0015 N1.01401-6101 1401 610 1	N=850	

PL-number	pf./ applicable for	OE/ OEM-Ref.	Dimension	picture
059 999 016				
Sitzdämpfer seat dampers	Fahrgastsitze Vogel		N=700 L=73	

PL-number	pf./ applicable for	OE/ OEM-Ref.	Dimension	picture
059 999 020				
Sitzdämpfer seat dampers	Fahrgastsitz		N=400 L1=125 L2=185 2x M6	

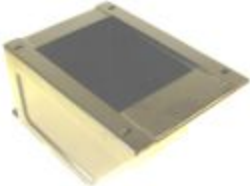
PL-number	pf./ applicable for	OE/ OEM-Ref.	Dimension	picture
059 400 000				
Sitzdämpfer seat dampers	Fahrersitz Grammer FA416	8.811.022.039	Auge D=15 Auge D=13	
059 500 111				
Sitzdämpfer seat dampers	MAN SL-SG-ÜL-NL-NG-RH LionsCity/ LionsClassic Neoplan N4516-20-21-22	81.62385.6009 1104 785 3	Auge D=12 Auge D=12	
059 850 000				
Clips	Fahrgastsitz Vogel/ Kiel Befestigungsclips Plastikschloß Sitzkissen			
059 014 000				
Sitz Seat	Reiseleitersitz universell			
059 000 098				
Konsole console	Fahrersitze Spurbreite 216mm universell			
059 000 099				
Anbausatz mounting kit	Adaptionskit Spurbreite 216 auf 230-280-320			

PL-number	pf./ applicable for	OE/ OEM-Ref.	Dimension	picture
076 001 000				
Türgelenk ball joint	unten Linksgewinde MB Bus Setra MAN Bus Neoplan	302 723 09 27 8.633.248.130 81.95303.6007 1104 739 0	M10x1 L=95	
076 001 001				
Türgelenk ball joint	unten Rechtsgewinde MB Bus Setra MAN Bus Neoplan	000 764 06 29 8.633.248.131 81.95303.6006 1104 730 5	M10x1 L=95	
076 001 002				
Türgelenk ball joint	Neoplan Stadtwagen	1104 760 3 N1.01104-7603		
076 001 003				
Türgelenk ball joint	Neoplan Stadtwagen	1104 760 4 N1.01104-7604		
076 001 100				
Türgelenk ball joint	MAN Bus SR-SÜ-ÜL-NL-NG-EL LionsCity/ LionsCityDD Neoplan N4516-20-21-22	81.95303.6004 1104 730 7 1104 741 3	M16/ M10	
076 001 201				
Türgelenk ball joint	mit Potentiometer Außenschwenktür MB Bus O405/ 405N-GN MAN Bus NL-NG-EL LionsCity/ LionsClassic Neoplan	357 720 31 27 81.95301.0097 88.74967.6003 2401 756 00		
076 001 202				
Potentiometer	elektrischer Türantrieb MAN Bus Neoplan	81.25907.6022 88.25907.6004 N1.01104-6834 1104 683 4		

PL-number	pf./ applicable for	OE/ OEM-Ref.	Dimension	picture
076 001 203				
Türgelenk ball joint	mit Potentiometer Neoplan Stadtwagen	N1.01104-7306 1104 730 6		

PL-number	pf./ applicable for	OE/ OEM-Ref.	Dimension	picture
076 001 204				
Türsensor door switch	MB Bus Citaro	001 820 42 97 001 821 79 60		

PL-number	pf./ applicable for	OE/ OEM-Ref.	Dimension	picture
076 001 206				
Türsensor door switch	MB Bus O407 MAN Bus NL-NG LionsCity/ LionsCityDD Solaris Urbino18 Volvo Daf	000 820 42 97 81.25907.0322 0170.480.000 13303800 1518023		

PL-number	pf./ applicable for	OE/ OEM-Ref.	Dimension	picture

PL-number	pf./ applicable for	OE/ OEM-Ref.	Dimension	picture

PL-number	pf./ applicable for	OE/ OEM-Ref.	Dimension	picture

PL-number	pf./ applicable for	OE/ OEM-Ref.	Dimension	picture

PL-number	pf./ applicable for	OE/ OEM-Ref.	Dimension	picture
076 005 000				
Führungsrolle oben roll up	MB & MAN Busse	305 723 00 68 81.74940.0056		
076 005 001				
Fangbolzen für Tür unten catch bolt for door	MB & MAN Busse	000 723 02 38 81.74940.0075		
076 005 002				
Türführung Plastik unten door steering	MB Bus MAN Bus Solaris Neoplan	305 723 00 36 81.74364.0009 81.74940.0054 2403.837.10 1104 758 2		
076 006 000.2				
Türgummi door seal	universell mit Messinghülse	81.74969.0045 1104 706 1		
076 006 001				
Türgummi door seal	MB links	357 720 11 54		
076 006 002				
Türgummi door seal	MB rechts	357 720 12 54		
076 006 100				
Türgummi door seal	MAN links	81.96101.0733 81.74940.0531		

PL-number	pf./ applicable for	OE/ OEM-Ref.	Dimension	picture
076 006 101				
Türgummi door seal	MAN rechts	81.96101.0732 81.74940.0532		

PL-number	pf./ applicable for	OE/ OEM-Ref.	Dimension	picture
076 007 001				
Türzylinder door cylinder	Bode und Masats MB Bus Setra MAN Bus Neoplan	000 763 55 01 632 760 01 03 8.633.251.000 8.633.174.067 81.74910.6046 81.74910.6047	D=100	

PL-number	pf./ applicable for	OE/ OEM-Ref.	Dimension	picture
076 007 101				
Reparaturset repair-set for door cylinder	Bode und Masats	000 763 64 01 000 763 07 17 8.633.221.128 81.96502.6092 36.74940.6043 1402 473 6	D=100	

PL-number	pf./ applicable for	OE/ OEM-Ref.	Dimension	picture
076 007 005				
Türzylinder door cylinder	MB Bus Citaro Solaris	000 760 24 05 000 760 28 05		

PL-number	pf./ applicable for	OE/ OEM-Ref.	Dimension	picture
076 006 006				
Türzylinder door cylinder	Bode 24V grün MB Bus MAN Bus Neoplan	005 820 73 42 005 820 11 42 81.28601.6073 1104 647 5 N.101104.6475		







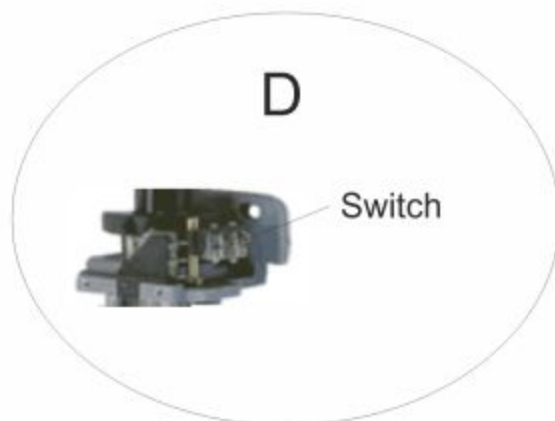
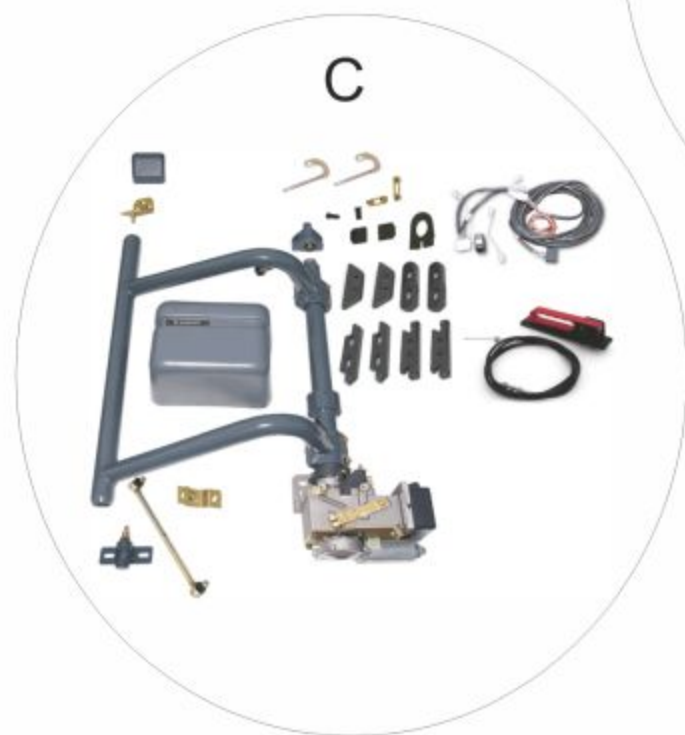
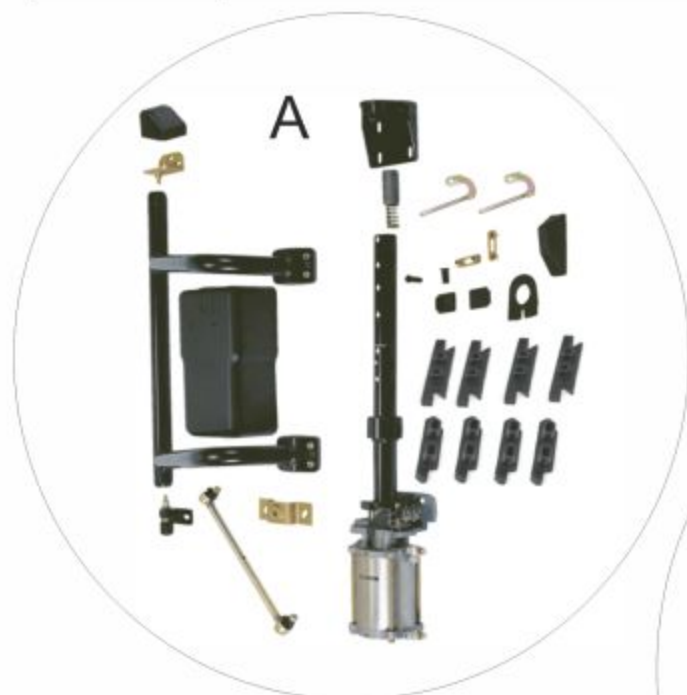

PL-number	pf./ applicable for	OE/ OEM-Ref.	Dimension	picture
076 007 013				
Türzylinder door cylinder	Wabco 422 802 306 0 422 802 300 0 422 802 301 0 422 802 402 0	81.74910.6017 81.74910.6021 1102 448 5		

PL-number	pf./ applicable for	OE/ OEM-Ref.	Dimension	picture
076 007 013.1				
Reparaturset repair-set for door cylinder		000 763 74 01 81.74910.6024 422 802 000 2		

ARG: 076 009 - Tür-Komplettsets/ vertical Door cylinder Repair Kit

Türtechnik (Tür-Spindelantriebe)			
PL-number	Description	pf./ applicable for	picture
076 009 000PL	Drehsäule-Spindeltrieb kompl. (pf.Bode-Türzylinder)	Bode	A
076 009 001PL	Drehsäule-Spindeltrieb kompl. (pf.Wabco-Türzylinder)	Wabco	B
076 009 002PL	Drehsäule-Spindeltrieb kompl. (pf.elektrischen Türzylinder)	MB Sprinter/ Iveco Daily	C
076 009 050	Reparatursatz Spindeltrieb (ohne Microschalter/ without switch)	Bode/ Wabco	D
076 009 051	Reparatursatz Spindeltrieb (mit Microschalter/ with switch)	Bode/ Wabco	D



PL-number	pf./ applicable for	OE/ OEM-Ref.	Dimension	picture
043 120 000				
Türöffnungsschalter mit Druckkappe door opening switch	MB Bus Setra MAN Bus Neoplan	004 545 99 14 81.25503.6107 81.25503.6164 81.25503.6232 81.25503.6239		
043 120 010				
Türöffnungsschalter door opening switch	Neoplan			
043 120 014				
Türöffnungsschalter door opening switch	Setra 200er Serie Tür1			
043 120 015				
Türöffnungsschalter door opening switch	Setra 200er Serie Tür2			
043 120 016				
Türöffnungsschalter door opening switch	Sensorschalter mit Vibration	013 820 10 10		
043 120 017				
Türöffnungsschalter door opening switch	Sensorschalter Rollstuhl-Kinderwagen	013 820 11 10		
043 120 018				
Türöffnungsschalter door opening switch	Sensorschalter ohne Vibration			
043 120 099				
Türöffnungsschalter door opening switch	alte Ausführung alle Busse old door system for all buses			

PL-number	pf./ applicable for	OE/ OEM-Ref.	Dimension	picture
046 026 004				
Türnothahn Emergency valve door opening	MB Bus	629 429 01 44		

PL-number	pf./ applicable for	OE/ OEM-Ref.	Dimension	picture
046 026 006				
Türnothahn Emergency valve door opening	Solaris	2406.255.000		

PL-number	pf./ applicable for	OE/ OEM-Ref.	Dimension	picture
046 026 007				
Türnothahn Emergency valve door opening	MAN Bus SÜ-SG-SL-RH LionsCity/ LionsClassic Neoplan	81.52170.6073 81.51230.0026 2406 180 00		

PL-number	pf./ applicable for	OE/ OEM-Ref.	Dimension	picture
046 026 010				
Türnothahn Emergency valve door opening	Setra MAN Bus SR-SL-SG-SÜ ÜL-NL-NG-EL-NG LionsCity/ LionsClassic LionsStar Neoplan N4516-20-21-22	8.283.982.000 81.52170.6077 81.52130.6086 1102 647 00		

PL-number	pf./ applicable for	OE/ OEM-Ref.	Dimension	picture
046 026 011				
Türnothahn Emergency valve door opening	MB Bus Setra MAN Bus SR-SL-SG-SÜ ÜL-NL-NG-EL-NG LionsCity/ LionsClassic LionsStar Neoplan N4516-20-21-22	000 760 23 57 8.285.376.000 81.52170.6134 81.52170.6137 1104 775 9 N1.01104-7759		

PL-number	pf./ applicable for	OE/ OEM-Ref.	Dimension	picture
076 000 200				
Türbürste door brush	alte Ausführung Busse all old buses			

PL-number	pf./ applicable for	OE/ OEM-Ref.	Dimension	picture
046 027 000				
Türventil door solenoid valve	Ausführung Bosch Reise- und Überlandbusse	36.74920.6001 1104 777 2		







PL-number	pf./ applicable for	OE/ OEM-Ref.	Dimension	picture
046 027 000.2				
Rep.-Satz Türventil door solenoid repair kit	Ausführung Bosch 046 027 000			

PL-number	pf./ applicable for	OE/ OEM-Ref.	Dimension	picture
046 027 001				
Türventil door solenoid valve	Stadtbusse MB MAN Neoplan Volvo RVI	000 760 27 78 88.74920.6003 1500 096 2 N1.01500.0962 56200005 501004310		

PL-number	pf./ applicable for	OE/ OEM-Ref.	Dimension	picture
046 027 002				
Türventil door solenoid valve	Ausführung Wabco Reise- und Überlandbusse	000 760 03 78 8.633.101.000 8.633.183.000 81.74920.6017 1104 771 4 2406 124 00 42323618		

PL-number	pf./ applicable for	OE/ OEM-Ref.	Dimension	picture
046 027 002.1				
Rep.-Satz Türventil door solenoid repair kit	Ausführung Wabco 046 027 002	472 017 000 2		

PL-number	pf./ applicable for	OE/ OEM-Ref.	Dimension	picture
026 027 006				
Türventil MTS door solenoid valve	MB Bus MAN Bus Neoplan Solaris Volvo Bus	000 760 70 78 88.25902.6020 1402 166 0 2410.006.901 13302122 20550838		

PL-number	pf./ applicable Dimension	material	OE/ OEM-Ref.	picture
099 400 038				
TürschlieÙkeil door closing tappet	oben/ top 118x38x11/23	metal	357 723 00 03 81.75340.0059 1104 725 0	
099 400 038.1				
TürschlieÙkeil door closing tappet	oben/ top 123x28x12	metal		
099 400 038KUNSTSTOFF				
TürschlieÙkeil door closing tappet	oben/ top 116x28x16/38	plastic		
099 400 039				
TürschlieÙkeil door closing tappet	oben/ top 101x28x11/23	metal	1104 739 9	
099 400 039.1				
TürschlieÙkeil door closing tappet	oben/ top 101x28x132	metal		
099 400 039KUNSTSTOFF				
TürschlieÙkeil door closing tappet	oben/ top 99x28x17/38	plastic		
099 400 040				
TürschlieÙkeil door closing tappet	unten/ below 116x26x11/32	metal	357 723 03 03 000 733 02 86 1104 725 5	

PL-number	pf./ applicable Dimension	material	OE/ OEM-Ref.	picture
099 400 040.1				
TürschlieÙkeil door closing tappet	unten/ below 127x25x13	metal		
099 400 040.2				
TürschlieÙkeil door closing tappet	unten/ below 113x24x11/21	metal		
099 400 040.3				
TürschlieÙkeil door closing tappet	unten/ below 124x26x11/21	metal		
099 400 041				
TürschlieÙkeil door closing tappet	unten/ below 108x24x9/27	metal	1104 731 3	
099 400 041.1				
TürschlieÙkeil door closing tappet	unten/ below 108x26x13	metal		
099 400 041.2				
TürschlieÙkeil door closing tappet	unten/ below 115x24x7/16	metal		
099 603 086				
TürschlieÙkeil door closing tappet	60x25x15	Alu		
099 400 058				
Schaube TürschlieÙkeil	DIN 6912 M8x40	metal		

PL-number	pf./ applicable for	material	Dimension	picture
086 000 002				
Radkappe wheel cover	VA/ front axle Design Vinci1	metal Stainless steel	22,5"	

PL-number	pf./ applicable for	material	Dimension	picture
086 000 003				
Radkappe wheel cover	HA/ rear axle Design Vinci1	metal Stainless steel	22,5"	

PL-number	pf./ applicable for	material	Dimension	picture
086 000 004				
Radkappe wheel cover	VA/ front axle Design Vinci1	metal CR-poliert CR-polished	22,5"	

PL-number	pf./ applicable for	material	Dimension	picture
086 000 005				
Radkappe wheel cover	HA/ rear axle Design Vinci1	metal CR-poliert CR-polished	22,5"	

PL-number	pf./ applicable for	material	Dimension	picture
086 000 006				
Halter Radkappen holder wheel cover	VA und HA Vinci1+2	plastic	all	

PL-number	pf./ applicable for	material	Dimension	picture
086 000 006.1				
Plastikkappe mitte plastiv cover	VA und HA Vinci1+2	plastic	all	

PL-number	pf./ applicable for	material	Dimension	picture
086 000 007.1				
6-Kant-Schlüssel tool for holder	Schlüssel zum Lösen und Befestigen der Radkappe tool for mounting wheel cover	metal/ plastic		

PL-number	pf./ applicable for	material	Dimension	picture
086 000 016				
Radkappe Classic wheel cover model classic	VA/ front axle	plastic flexibel	19,5"	

PL-number	pf./ applicable for	material	Dimension	picture
086 000 017				
Radkappen Classic wheel cover model classic	HA/ rear axle	plastic flexibel	19,5"	

PL-number	pf./ applicable for	material	Dimension	picture
086 000 022				
Radkappe wheel cover	VA/ front axle	metal CR-polieret CR-polished	17,5"	

PL-number	pf./ applicable for	material	Dimension	picture
086 000 023				
Radkappe wheel cover	HA/ rear axle	metal CR-polieret CR-polished	17,5"	

PL-number	pf./ applicable for	OE/ OEM-Ref.	Dimension	picture
086 00 025				
Radkappe Classic wheel cover model classic	VA/ front axle		17,5"	

PL-number	pf./ applicable for	material	Dimension	picture
086 000 026				
Radkappe Classic wheel cover model classic	HA/ rear axle	plastic flexibel	17,5"	

PL-number	pf./ applicable for	material	Dimension	picture
086 000 027				
Radkappe wheel cover	VA/ front axle	metal CR-poliert CD-polished	17,5"	

PL-number	pf./ applicable for	material	Dimension	picture
086 000 028				
Radkappe wheel cover	HA/ rear axle	metal CR-poliert CR-polished	17,5"	

PL-number	pf./ applicable for	material	Dimension	picture
086 000 031				
Radkappe Classic wheel cover model classic	VA/ front axle	plastic flexibel	22,5"	

PL-number	pf./ applicable for	material	Dimension	picture
086 000 032				
Radkappe Classic wheel cover model classic	HA/ rear axle	plastic flexibel	22,5"	

PL-number	pf./ applicable for	material	Dimension	picture
086 000 043				
Radkappe wheel cover	VA/ front axle HA/ rear axle	plastic weiß white	22,5"	

PL-number	pf./ applicable for	material	Dimension	picture
086 000 044				
Radkappe wheel cover	VA/ front axle HA/ rear axle	plastic silber silver	22,5"	

PL-number	pf./ applicable for	material	Dimension	picture
086 000 045				
Radkappe wheel cover	VA/ front axle	plastic weiß white	22,5"	

PL-number	pf./ applicable for	material	Dimension	picture
086 000 046				
Radkappe wheel cover	HA/ rear axle	plastic weiß white	22,5"	

PL-number	pf./ applicable for	material	Dimension	picture
086 000 045.2				
Radkappe wheel cover	VA/ front axle	plastic weiß white	17,5"	

PL-number	pf./ applicable for	material	Dimension	picture
086 000 046.2				
Radkappe wheel cover	HA/ rear axle	plastic weiß white	17,5"	

PL-number	pf./ applicable for	material	Dimension	picture
086 000 047				
Radkappe wheel cover	Setra 500er Serie VA/ front axle HA/ rear axle	plastic weiß white	22,5"	

PL-number	pf./ applicable for	material	Dimension	picture
086 000 048				
Radkappe wheel cover	Setra 500er Serie VA/ front axle HA/ rear axle	metal Stainless steel	22,5"	

PL-number	pf./ applicable for	material	Dimension	picture
086 000 049				
Radkappe wheel cover	Setra 400er Serie VA/ front axle HA/ rear axle	metal Stainless steel	22,5"	

PL-number	pf./ applicable for	material	Dimension	picture
086 000 052				
Radkappe wheel cover	MB O580 Travego VA/ front axle HA/ rear axle	metal Stainless steel	22,5"	

PL-number	pf./ applicable for	material	Dimension	picture
086 000 053				
Radkappe wheel cover	Neoplan VA/ front axle	metal Stainless steel	22,5"	

PL-number	pf./ applicable for	material	Dimension	picture
086 000 054				
Radkappe wheel cover	Neoplan VA/ rear axle	metal Stainless steel	22,5"	

PL-number	pf./ applicable for	material	Dimension	picture
086 000 058				
Radkappe wheel cover	MB Sprinter VA/ front axle	metal CR-poliert CR-polished	16"	

PL-number	pf./ applicable for	material	Dimension	picture
086 000 059				
Radkappe wheel cover	MB Sprinter bei Doppelbereifung HA/ rear axle by double wheel	metal CR-poliert CR-polished	16"	

PL-number	pf./ applicable for	material	Dimension	picture
Radkappe wheel cover				

PL-number	pf./ applicable for	material	Dimension	picture
Radkappe wheel cover				

PL-number	pf./ applicable for	material	Dimension	picture

PL-number	pf./ applicable for	material	Dimension	picture

PL-number	pf./ applicable for	material	Dimension	picture

PL-number	pf./ applicable for	material	Dimension	picture
086 110 001				
Radmutterabdeckung wheel bold cover	VA/ front axle	metal Edelstahl Stainless steel	19,5"	

PL-number	pf./ applicable for	material	Dimension	picture
086 110 003				
Radmutterabdeckung wheel bold cover	VA/ front axle	metal NC Schwarz/ black	22"	

PL-number	pf./ applicable for	material	Dimension	picture
086 110 003				
Radmutterabdeckung wheel bold cover	VA/ front axle	metal NC Nickel-Crom	22"	

PL-number	pf./ applicable for	material	Dimension	picture
086 110 004				
Radmutterabdeckung wheel bold cover	VA/ front axle	metal Edelstahl Stainless steel	22"	

PL-number	pf./ applicable for	material	Dimension	picture
086 110 005				
Radmutterabdeckung wheel bold cover	VA/ front axle	metal Edelstahl schwarz Stainless steel black	22"	

PL-number	pf./ applicable for	material	Dimension	picture
086 110 007				
Radmutterabdeckung wheel bold cover	VA/ front axle	metal Edelstahl Stainless steel	22"	

PL-number	pf./ applicable for	material	Dimension	picture
086 110 009				
Radmutterabdeckung wheel bold cover	VA/ front axle Volvo	metal NC Nickel-Crom	22"	ohne Bild without picture

PL-number	pf./ applicable for	material	Dimension	picture
086 110 010				
Radmutterabdeckung wheel bold cover	VA/ front axle Iveco	metal NC Nickel-Crom	22"	ohne Bild without picture

PL-number	pf./ applicable for	material	Dimension	picture
086 110 011				
Radmutterabdeckung wheel bold cover	VA/ front axle	plastic	22"	

PL-number	pf./ applicable for	material	Dimension	picture
086 110 012				
Radmutterabdeckung wheel bold cover	VA/ front axle	plastic	22"	

PL-number	pf./ applicable for	material	Dimension	picture

PL-number	pf./ applicable for	material	Dimension	picture

PL-number	pf./ applicable for	OE/ OEM-Ref.	Dimension	picture
099 602 100.1				
Klappenverschluß Flap Lock	manuell schließend manually closing		162x95x55	

PL-number	pf./ applicable for	OE/ OEM-Ref.	Dimension	picture
099 602 101				
Klappenverschluß Flap Lock	pneumatisch schließend pneumatic closing	36.97001.6002 1105 742 8 N1.01105-7428	158x95x47	

PL-number	pf./ applicable for	OE/ OEM-Ref.	Dimension	picture
099 602 105				
Klappenverschluß Flap Lock	pneumatisch schließend pneumatic closing		158x142x55	

PL-number	pf./ applicable for	OE/ OEM-Ref.	Dimension	picture
099 602 106				
Klappenverschluß Flap Lock	Außenschwingtür manuell schließend manually closing			

PL-number	pf./ applicable for	OE/ OEM-Ref.	Dimension	picture
099 602 111				
Klappenverschluß Flap Lock	Setra S416HDH mit intgrierter Umrißleuchte manuell schließend manually closing	629 750 10 93 629 750 23 93		

PL-number	pf./ applicable for	OE/ OEM-Ref.	Dimension	picture
099 602 111.1				
Klappenverschluß Flap Lock	LED- Seitenmarkierungsleuchte LED side-marker lamp	629 540 06 45		

PL-number	pf./ applicable for	OE/ OEM-Ref.	Dimension	picture
099 602 111.2				
Klappenverschluß Flap Look	Griff einzeln pf. 099 602 111			
PL-number	pf./ applicable for	OE/ OEM-Ref.	Dimension	picture
099 602 121				
Klappenverschluß Flap Look	Setra 200er Serie		183x139	
PL-number	pf./ applicable for	OE/ OEM-Ref.	Dimension	picture
099 602 122				
Klappenverschluß Flap Look	Setra 315UL		225x110	
PL-number	pf./ applicable for	OE/ OEM-Ref.	Dimension	picture
099 602 374				
Klappenverschluß Flap Look	Griffmulde		130x70x36	
PL-number	pf./ applicable for	OE/ OEM-Ref.	Dimension	picture
099 602 379				
Klappenverschluß Flap Look	Griffmulde		130x70x36	
PL-number	pf./ applicable for	OE/ OEM-Ref.	Dimension	picture
099 602 578				
Klappenverschluß Flap Look	manuell schließend manually closing		164x99x55	

PL-number	pf./ applicable for	OE/ OEM-Ref.	Dimension	picture
099 602 600				
Klappenverschluß Flaps Look	mit LED- Seitenmarkierungsleuchte manuell schließend LED side-marker lamp manually closing		239x126x51	

PL-number	pf./ applicable for	OE/ OEM-Ref.	Dimension	picture
099 602 602				
Klappenverschluß Flap Look	mit LED- Seitenmarkierungsleuchte pneumatisch schließend LED side-marker lamp pneumatic closing	36.97116.6000	239x126x51	

PL-number	pf./ applicable for	OE/ OEM-Ref.	Dimension	picture
099 602 662				
Klappenverschluß Flap Look	manuell schließend manually closing		158x144x52	

PL-number	pf./ applicable for	OE/ OEM-Ref.	Dimension	picture
099 600 485				
Türschloß door lock	Drehriegelschloß links	81.97116.6059 1104 536 4		

PL-number	pf./ applicable for	OE/ OEM-Ref.	Dimension	picture
099 600 486				
Türschloß door lock	Drehriegelschloß rechts	81.97116.6058 1104 536 5		

PL-number	pf./ applicable for	OE/ OEM-Ref.	Dimension	picture
099 600 487				
Schließkeil striker plate				

PL-number	pf./ applicable for	OE/ OEM-Ref.	Dimension	picture
099 600 488				
Verbindungstange connecting rod				

PL-number	pf./ applicable for	OE/ OEM-Ref.	Dimension	picture
099 900 007				
Schloß lock	Seitenplappenschloß Schließung PS200			

PL-number	pf./ applicable for	OE/ OEM-Ref.	Dimension	picture
099 900 104				
Schlüssel key	Vierkantdorschlüssel & Dreikant-Hohlschlüssel		8mm	

PL-number	pf./ applicable for	OE/ OEM-Ref.	Dimension	picture
099 602 8875				
Schloß lock	Schließzylinder Schließung NS8875			

PL-number	pf./ applicable for	OE/ OEM-Ref.	Dimension	picture
099 602 8875S				
Schlüssel key	Schlüssel Schließung N8875			

PL-number	pf./ applicable for	OE/ OEM-Ref.	Dimension	picture

PL-number	pf./ applicable for	OE/ OEM-Ref.	Dimension	picture

PL-number	pf./ applicable for	OE/ OEM-Ref.	Dimension	picture

PROFILINE die Marke/ PROFILINE Brandname

Qualitäts- und Gewährleistungszertifikat

Der Eigner der Marke "Profiline Kleemann" versichert die Zuverlässigkeit und Langlebigkeit seiner Ersatzteile.

Vom Erstmuster bis zum Endprodukt unterliegen alle "Profiline Kleemann" Produkte strengen Qualitätskriterien. Regelmäßige Materialprüfungen und Stichproben in puncto Funktionalität sowie eine professionelle Lagerhaltung versprechen einen gleichbleibenden hohen Qualitätsstandard der "Profiline Kleemann" Produkte und gewähren, dass nur einwandfreie Ware das Lager verlässt.

Sollte dennoch ein Material- oder ein Fertigungsfehler auftreten, übernimmt der Eigner der Marke "Profiline Kleemann" die Reparatur oder den Ersatz des beanstandeten Ersatzteils, sowie die Vergütung etwaiger Neben- oder Folgeschäden. Ein derartiger Fall unterliegt jedoch einer Einzelfallbewertung.

Die Gewährleistungsfrist für Neuteile der Marke "Profiline Kleemann" beträgt 12 Monate beginnend ab Verkaufsdatum.

Eine Schadensmeldung muss dem Eigner der Marke "Profiline Kleemann" sofort nach Auftreten des Schadens mitgeteilt werden.

Ungültig werden diese Gewährleistungsbedingungen, wenn das gelieferte Produkt von fremder Seite oder durch Einbau von Teilen fremder Herkunft verändert wird.

Ungültig werden diese Gewährleistungsbedingungen ebenfalls, wenn der Einbau oder die Handhabung unsachgemäß durchgeführt wurde.

Offenbarer Verschleiß und Beschädigungen durch unsachgemäße Behandlung sind von der Gewährleistung ausgeschlossen.

Unsere allgemeinen Geschäftsbedingungen entnehmen Sie bitte unserer Homepage www.profiline.com.



QUALITY AND WARRENTY CERTIFICATE !!!

our terms of business are defined in our homepage www.profiline.com

The owner of the brand "Profiline Kleemann" assures failsafe operation, long service life of all "Profiline Kleemann" spare parts.

From the initial sample up the final product all quality criterias will be considered, regular inspections and random functionality tests of our products as well as a professional warehousing ensure that only parts of best quality leave the warehouse.

Insofar as nothing to the contrary is expressly agreed to, the owner of "Profiline Kleemann" provides a warranty for freedom from defects of the delivered parts for a duration of 12 months, commencing date = date of invoice. In case a material or manufacturing defect should occur we will replace the defective "Profiline Kleemann" product free of charge at anytime during the warranty period, an possible defect has to report to the owner of the brand "Profiline Kleemann" right after arise.

As far as repairs are possible the right to replace the defective parts is waived. Under certain circumstances the owner of "Profiline Kleemann" may offer his assistance for labour reimbursement when due to the failure of a "Profiline Kleemann" part collateral damages occur.

These cases will be handled on a case by case basis only and should be notified in writing withim a period of 1 month.

The conditions of this warranty become invalid if the parts delivered is modified, unless the defect has no causal can use with the modification.

"Profiline Kleemann" products have to be mounted by qualified personel only, the instructions of the vehicle manufacturers have to be followed. Moreover this guarantee excludes wear and tear damages, caused by improper usage.



CHEAP

FAST

RELIABLE



**TWENTY YEARS EXPERIENCE
IN THE AREA OF
BUS AND TRUCK PARTS**

Version 10-2018

PROFILINE DELIVERY SPARE PARTS WORLDWIDE